



- 2N® Helios IP Verso
- 2N® Helios IP Vario
- 2N® Helios IP Force
- 2N® Helios IP Safety
- 2N® Helios IP Uni
- 2N® Indoor Touch
- 2N® NetSpeaker
- 2N® SIP Speaker
- 2N® NetMic

From ideas to implementation



2N® Helios IP intercoms and public address systems

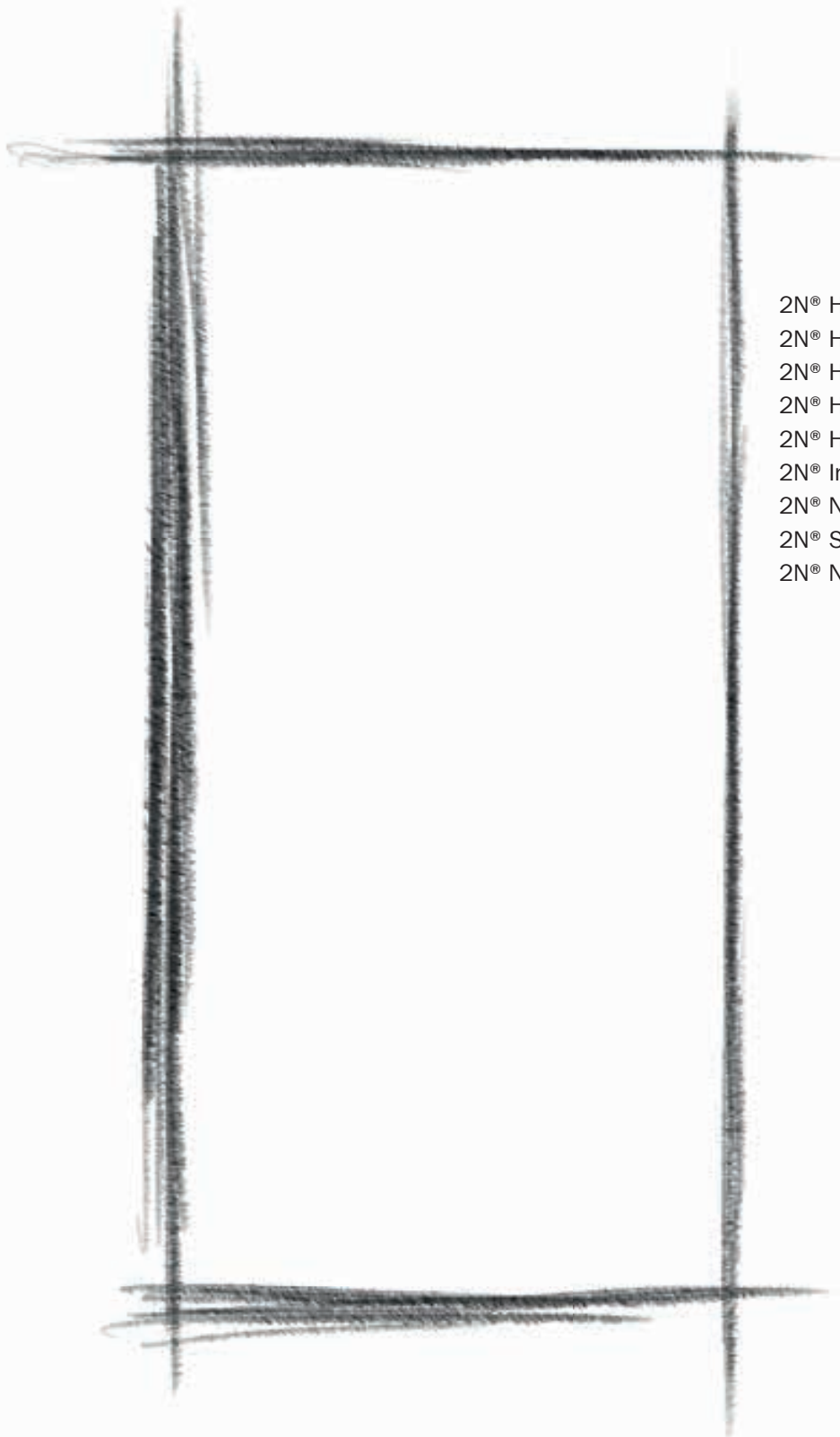

2N® Helios IP Verso
2N® Helios IP Vario
2N® Helios IP Force
2N® Helios IP Safety
2N® Helios IP Uni
2N® Indoor Touch
2N® NetSpeaker
2N® SIP Speaker
2N® NetMic

From ideas to implementation

Introduction



Dear customers and partners,

This completely new catalogue is intended for you, a small group of experts who, like us, draw, plan and design very carefully and seek out the best solution for their customers time and time again. And when you've found the best solution, turn your ideas into perfect results.

This catalogue is intended for you – architects, project engineers, fitters and, of course, all users of 2N products. We aim to provide you with a useful advantage in a competitive market. We want to give you the means to speed up your work, to find new areas with added value of your business, for the effective and comfortable creation of offers, project documentation, source material for discussions with clients and, naturally, for you to find the greatest utility for the customer.

We carried out extensive customer research, asked our customers throughout the world about their needs and wishes, and we looked carefully at how they use the existing equipment, what they appreciate and what they feel is missing and what annoys them. We have combined our years of experience with the survey results from our development team to create a range of products based on internet technologies intended for residential buildings, shopping centres, public spaces, motorways, hospitals and large office complexes.

Why read and use this catalogue?

- 2N communication systems do not need any new cabling or infrastructure – everything is linked and operates on a regular LAN network and the Internet
- The equipment can be located anywhere in the world. Thanks to the internet there are no limits on distance, the number of components or the number of zones
- You can monitor, control, configure and upgrade all the equipment remotely
- 2N voice and video communication can be controlled easily on tablets, mobile phones, computers or telephones
- The systems are designed to be open for cooperation with third-party products and they natively use http, 802x, RTP, WMA, MP3, ONVIF, H264, M-JPEG and many other commonly used network and audio-visual formats.

You can find the current electronic version of the catalogue on our pages www.2n.cz. The large number of documents in the download section will make the creation of project documentation easier and faster for you, and the recommended SW licences can be bought online on the 2N licence portal.

Not only do we aim to deliver a high-quality, reliable product but also simplicity, speed and comfort to your work and the purchase of our products. I hope we succeed in this task and that you will become our partner in the future and a co-creator of this and similar material. We are prepared to listen to you and constantly improve and develop our products, this catalogue and the entire complex of tools associated with it.

I wish you every success in your work and every satisfaction from 2N products.

A handwritten signature in blue ink, appearing to be 'Oldřich Stejskal'. The signature is fluid and stylized, with a large initial 'O' and 'S'.

Oldřich Stejskal

CEO of 2N TELEKOMUNIKACE a.s.



**2N® Helios
IP Verso**



**2N® Helios
IP Vario
2N® Helios
Vario**



**2N® Helios
IP Force
2N® Helios
Force**



**2N® Helios
IP Safety
2N® Helios
Safety**



**2N® Helios
IP Uni
2N® Helios
Uni**

10-11

12-13
N/A14-15
N/A16-17
N/A18-19
N/A

30-31

32-33
50-5134-35
52-5336-37
54-5538-39
56-57

62-65

66-69
80-8270-71
8372
8473
85

90-91

92-93
102-10394-95
104-10596-97
106-10798-99
108-109

116-121

122-125
122-125126-127
126-127128-129
128-129130-131
130-131

Contents



**2N®
Indoor Touch**

**2N®
NetSpeaker**

**2N®
SIP Speaker**

**2N®
NetMic**

20–21

22–23

24–25

N/A

Vision 8

40–41

42–43

44–45

46–47

Planning 26

73

78

79

79

Selection 58

100–101

110–111

112–113

114–115

Installation 88

132

133

No ideas are too bold ...

Using a simple graphic form we present door intercoms in their typical installations.



Vision





2N® Helios IP Verso

Only one can be perfect

The 2N® Helios IP Verso is a security intercom marked by its high degree of modularity. So it is entirely up to you whether to have a built-in HD camera with night vision, a smart card reader, or to fully integrate it into a camera and monitoring system.

2N® Helios IP Vario

First impression count

2N® Helios IP Vario is an ideal door intercom for offices where it is necessary to combine security and a smart design. It has a card reader, display camera or attendance system.





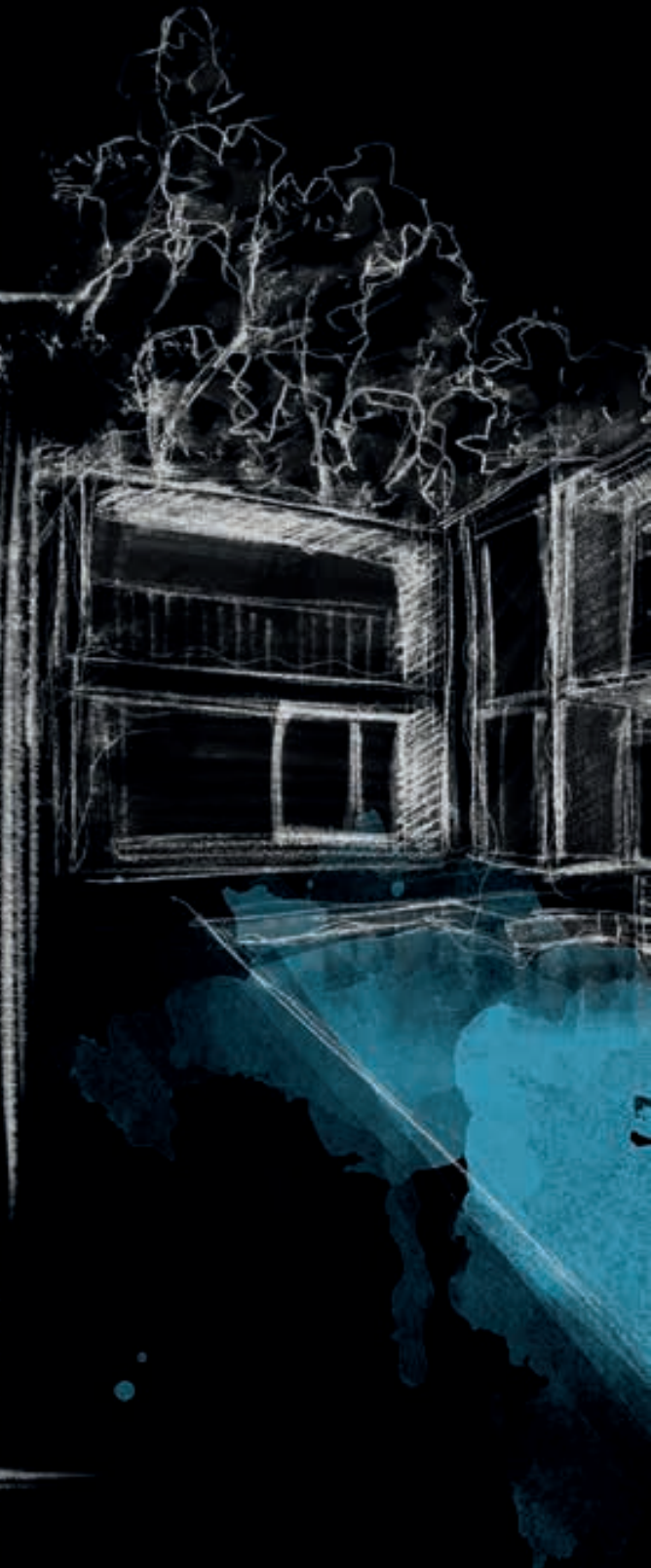



2N® Helios IP Force

A door guard for extreme conditions

2N® Helios IP Force is a robust door intercom for apartment complexes where it is necessary to ensure maximum resilience and security. An aluminium cover, camera with night vision and resilience to dust, water and vandals ensure that an area remains safe.



2N® Helios IP Safety

A highly visible aid when you're in distress

2N® Helios IP Safety is a security intercom for immediate communication with assistance, and fully functional even if immersed in water or at temperatures of -30°C . In both cases it is fully functional. It has a robust aluminium cover and comes in a distinct orange colour.



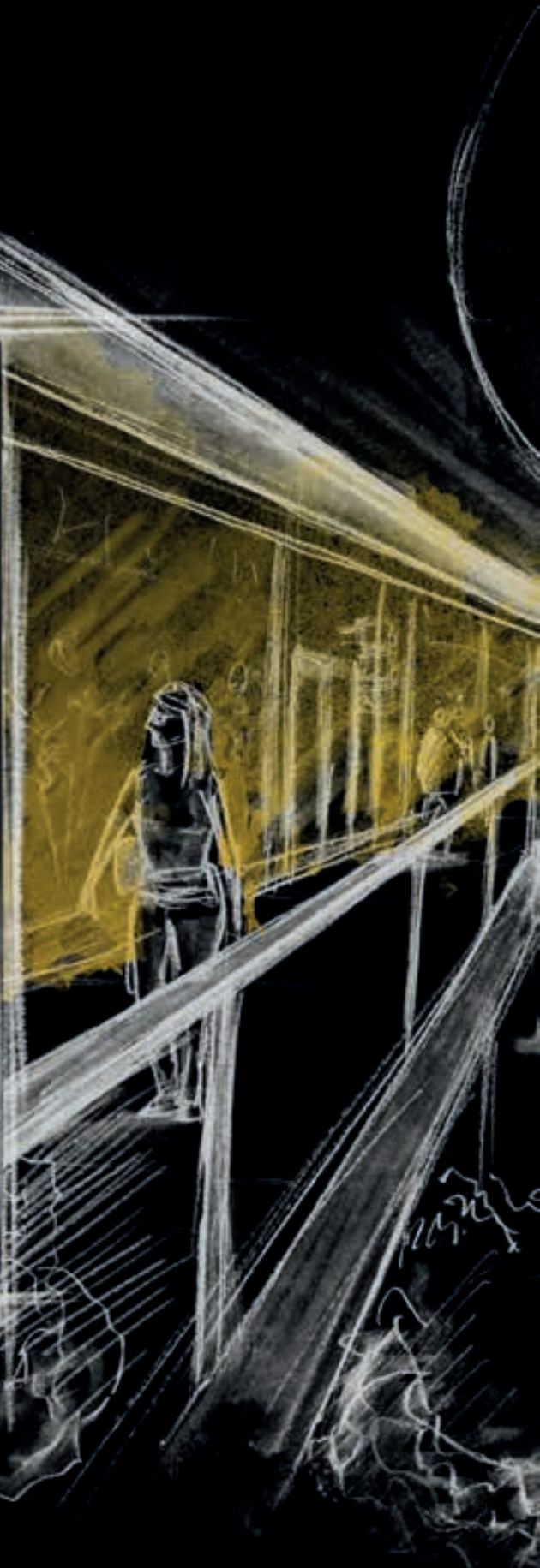

2N® Helios IP Uni

Great value for the money

2N® Helios IP Uni is an intercom which is very easy to install and is suitable for shopping centres, offices, museums or schools. Simple operation and connection with the IP world ensures that no one will get lost, or if they do they can contact the building receptionist or security guard straight away.

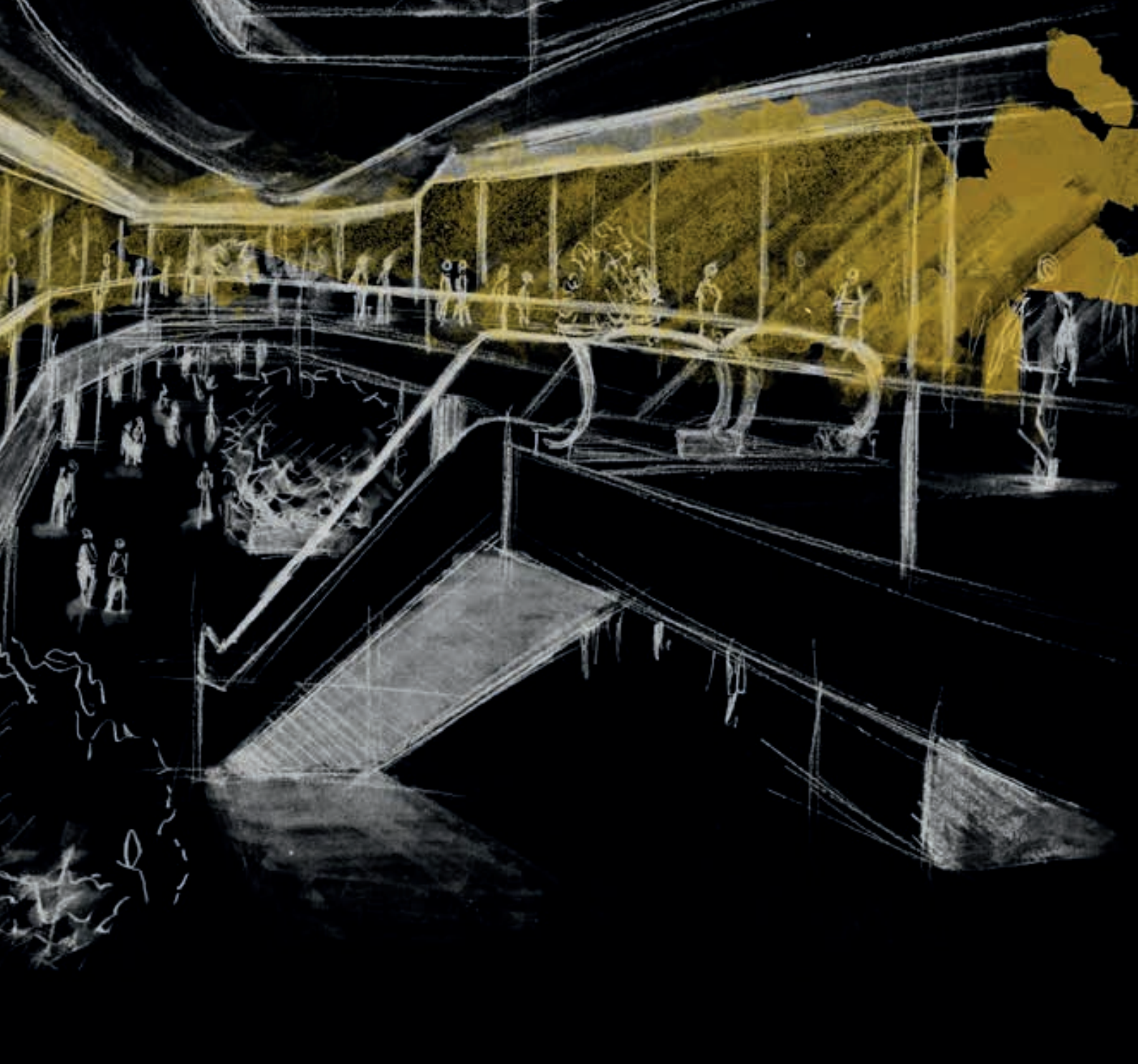

2N® Indoor Touch

Luxury door communication solution

The 2N® Indoor Touch panel is a combination of luxury, excellent design and simple control. By simply glancing at the display, you can see who is standing at the door, easily start a conversation, unlock the door and turn on the lights in the corridor or entrance hall.

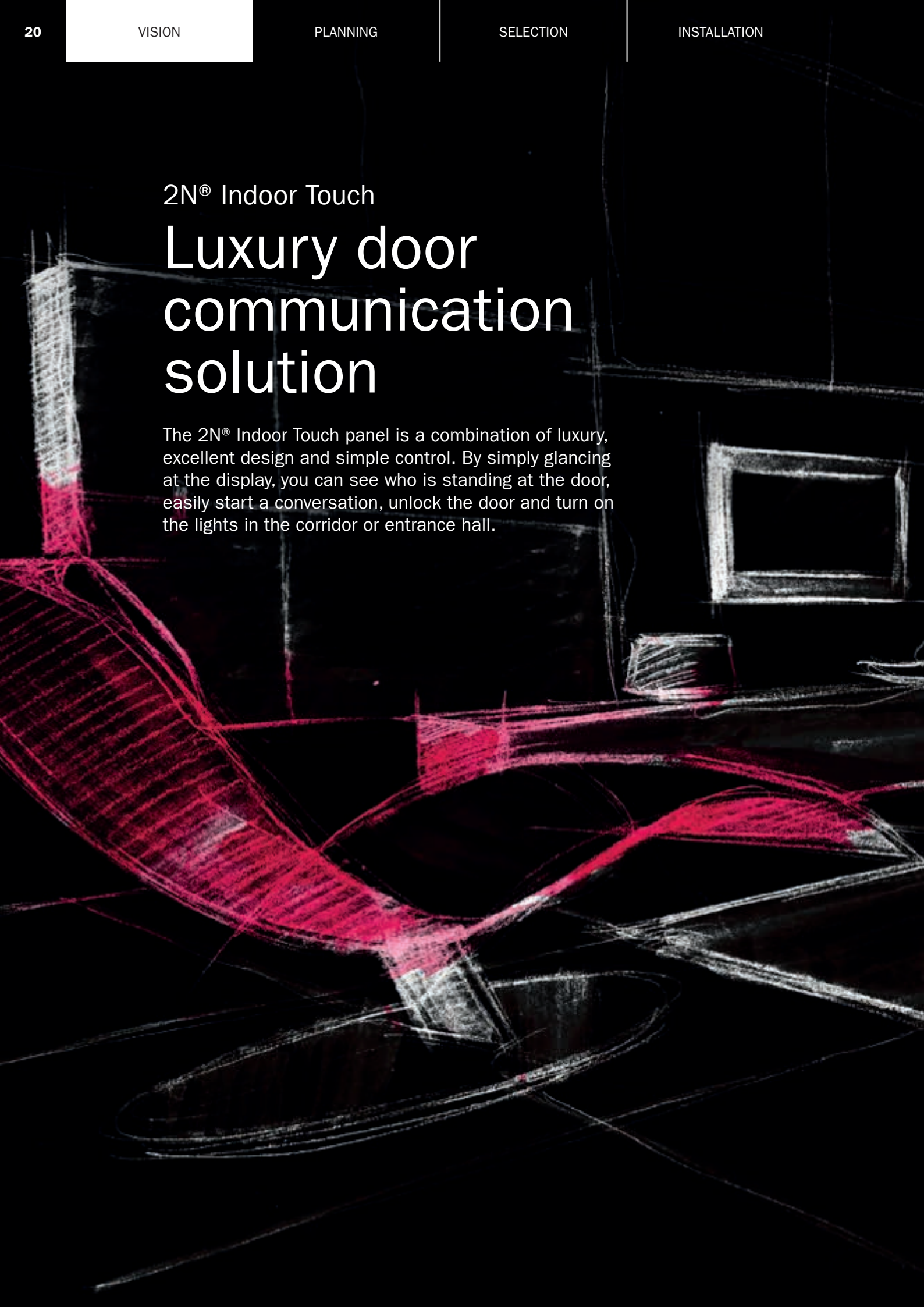



 Settings	 File Manager	 Installed Interooms
 Gallery	 Interoom	12:45 Monday 18.12.2014
 About	 Volume	 19°C

EV



2N[®] NetSpeaker

Turns your PC into a PA exchange

2N[®] NetSpeaker is an IP audio system suitable for installation in wellness centres, hotels, shopping centres and wherever the main requirement is for varying background music and announcements to selected zones and remote administration from one central place, even if it is thousands of kilometres away.

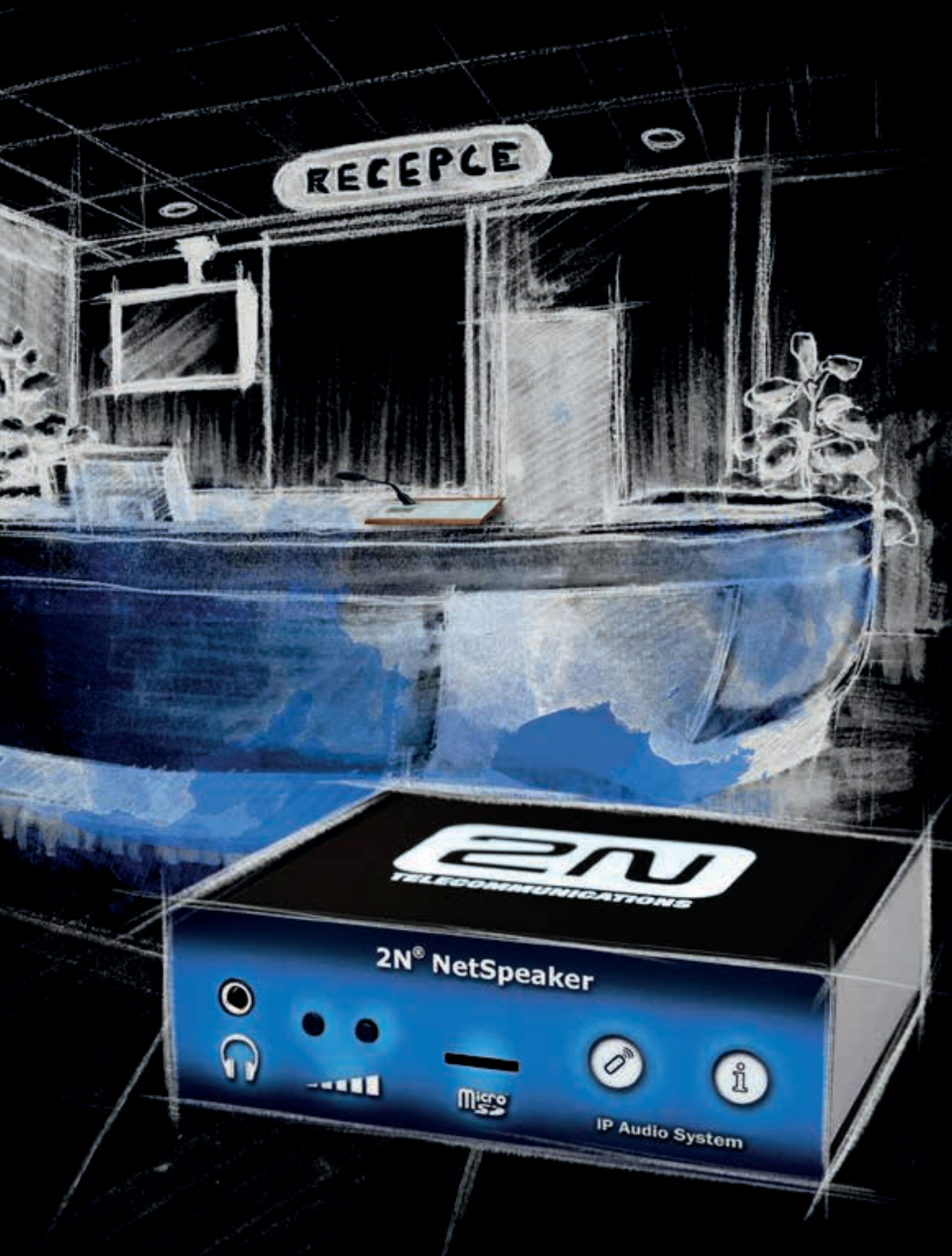



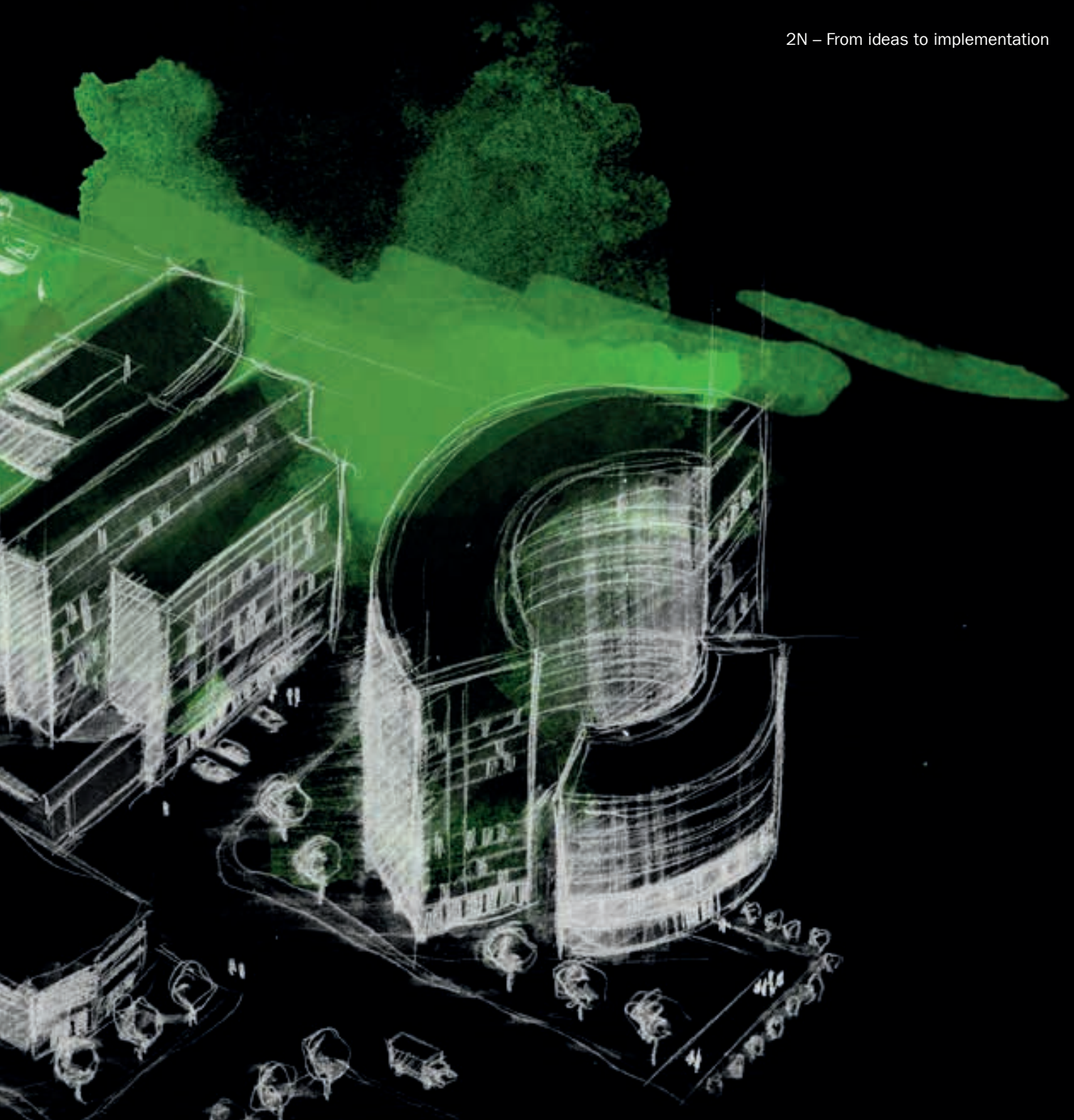

2N® SIP Speaker

Effective public address

2N® SIP Speaker is ideal aid for public announcements in a large company complex. The existing telephone exchange can be used with a speaker as a simple PA system. And the combination of the SIP protocol and multicast offers the possibility of sending announcements to all devices or selected individual zones.

Planning means the creation of the future ...

When planning our suggestions, information about recommended use and examples of connection in selected environments will help you.



Planning

Solution for IP environment

It is also increasingly necessary to integrate IP intercoms presented here into various systems such as access control in buildings, camera systems or security applications. In order for an intercom to meet all these demands it is essential for it to use IP technology, preferably the open protocol SIP.

We became aware of this fact in 2005, and in the following year we were one of the first on the market to introduce an IP version of our successful 2N® Helios communicator. Thanks to the hard work of a team of development specialists it became a cutting-edge device, able to tackle any challenges.

Security is the priority for 2N

When technology transforms your daily life and enhances your safety



The 2N® Helios IP intercom range not only provides convenient and sophisticated two-way communication, but also a comprehensive security solution for firms and individuals. As we all know, there has been an increasing emphasis on security in recent years, and we encounter various security measures at virtually every step.

At 2N, we also take security very seriously, and we are sure that we can meet all your needs in this area. Regardless of whether your primary interest is a system for building security, monitoring people at the entrance to your premises or connecting your attendance system, all these areas require a high level of security and protection. And intercoms in the 2N® Helios IP range, which are equipped with a whole range of security functions, can help you in these areas.

For clarity and easy comprehension, we have created a simple system of symbols called 2N 360° SECURITY SHIELD®, which encompasses all these security functions. This new form of intercom communication works on the principle that the customer's needs come first, complemented by an understanding of the customer's field of business. This is followed by a resolution of customer needs through security functions, all capped off with a proposed solution for a specific intercom installation. The simple system of symbols and distinct colour characteristics are complemented by the cutting-edge technology itself, which is the very best that the global IP intercom market can offer today.

We believe this new form of communication will give you a significant competitive advantage and help you stay ahead of the competition.

OVERVIEW OF IP INTERCOMS

Detailed overview of functions and parameters of IP intercoms for your better decision.

Intercoms	2N® Helios IP Verso	2N® Helios IP Force	2N® Helios IP Safety	2N® Helios IP Vario	2N® Helios IP Uni
Integrated camera	optional (HD)	optional	x	optional	x
Integrated microphone and speaker	yes	yes	yes	yes	yes
Audio line-in/ line-out	line-out	x	x	x	x
Buttons	up to 146	1, 2 or 4	1	up to 54	1 or 2
External buttons input	yes	optional	optional	optional	optional
Numerical keypad	optional	optional	x	optional	x
Internal RFID card reader	optional	optional	optional	optional	x
Display	x	x	x	optional	x
Integrated electric switch	yes	yes	yes	yes	yes
Loudspeaker power extension to 10W	x	yes	yes	x	x
Power supply POE 802.3af	yes	yes	yes	yes	yes
Power supply 12 V DC	yes	yes	yes	yes	yes
Tamper switch	optional	optional	optional	x	yes
IP coverage	IP54	IP65 / IP69K	IP65 / IP69K	IP53 with roof	IP54
Phone book positions	2000	2000	2000	2000	2
Substitute user if inaccessible	yes	yes	yes	yes	x
Security Relay support	yes	yes	yes	yes	yes
2N® Helios IP Eye support	yes	yes	x	yes	x

CONNECTIVITY IN IP ENVIRONMENT

IP intercoms from 2N can be connected with a wide range of external devices thanks to open standards:

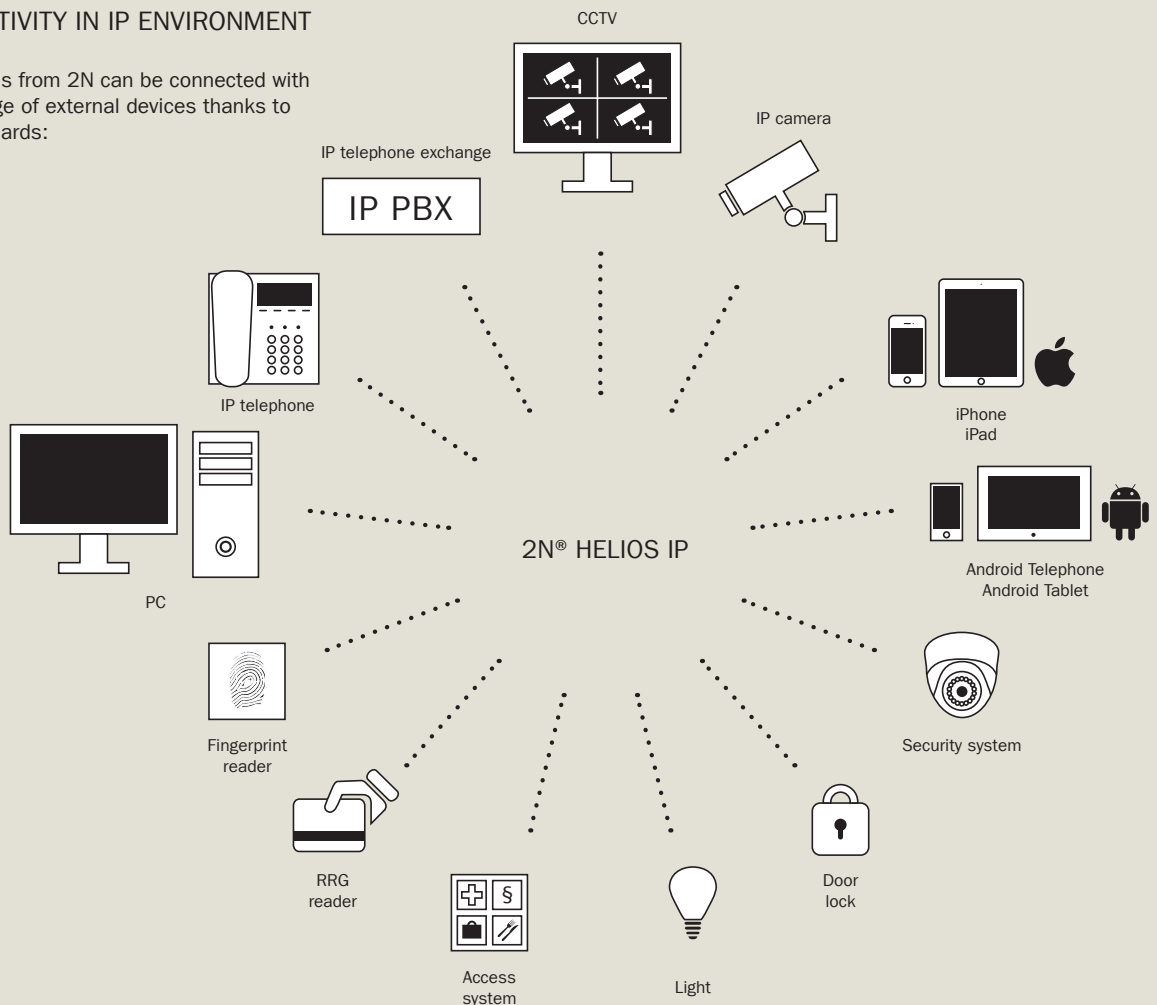

IP ENVIRONMENT

2N[®] Helios IP Verso



SUGGESTED USES

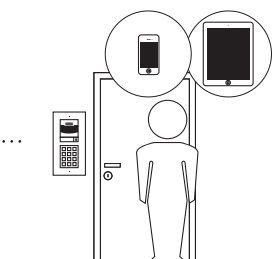

HD video

The built-in HD camera makes it possible to send a quality image to a tablet or smartphone



Night vision

Infrared night vision makes it possible to film a potential assailant even in deep darkness, without that person even knowing they are being filmed

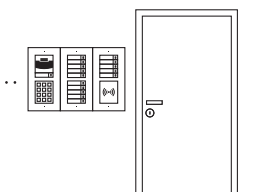

Modularity

Thanks to its modularity, any combination of intercom components may be chosen. This means that you can combine an attendance system with a key pad, name tags and a HD camera.



ONVIF



BOSCH

AVAYA

Alcatel-Lucent



RECOMMENDED USE

Office buildings

Office buildings are showcases for the firms that have their offices there; they should be a reflection of their success, progressiveness and stability. Therefore it is desirable to welcome all your visitors not only with a pleasant environment, but also with a perfect intercom at the entrance. The 2N® Helios IP Verso combines luxury design with the latest technologies in the area of communications and security. And because security is currently one of the hottest topics, the 2N® Helios IP Verso contains the most advanced camera in the world of intercoms, with high definition and night vision, which is usually only seen in professional CCTV cameras. Of course it can be integrated into all security systems, such as a CCTV or access system.

Main features:

- HD Camera with night vision
- Controlled building access (cards, codes)
- Supports attendance systems
- Voice and image to a standard tabletop telephone
- Integration with CCTV and access control systems

Public and commercial buildings

Government offices, schools or shopping centres – these are some of the typical environments for which the 2N® Helios IP Verso intercom has been designed. It meets the strictest requirements for modern design, modularity and security in one perfect unit. It is a device that allows visitors to enter and helps them orient themselves, and it restricts access by undesirable persons and monitors employee attendance. All this is made possible by unique functions such as easy integration into CCTV systems, ONVIF standard support, a HD camera with night vision and an RFID smartcard reader module, together with an attendance system for employees.

Main features:

- Representative and modular design
- HD camera that can be connected to a CCTV system
- Controlled building access (card, code)
- Supports attendance systems
- Collective administration of several intercoms via the internet

Residential area

The entrance to a home is a true reflection of its owner. The 2N® Helios IP Verso intercom reveals that you like modern design and quality materials, that the safety of your loved ones is of the utmost importance and that you demand state-of-the-art technology. And what exactly do all of these details say about you? This intercom, with its luxury design made of zinc alloy, works with the latest IP technologies, such as integration with e-mail; it has a high definition camera, the latest web interface and includes security functions such as integration with camera systems, night vision and protection against lock tampering. As a bonus, the 2N® Helios IP Verso offers you the ability to call mobile devices or tablets, so you can operate your door from the comfort of your own garden.

Main features:

- Voice and video reception on your mobile phone or tablet
- Photos of visitors sent to your e-mail
- HD camera, which may be connected to your home CCTV system
- Remote control of other equipment (lights, garage doors)
- Connection to home automation systems

EXAMPLE OF CONNECTION OF THE 2N® HELIOS IP VERSO IN AN OFFICE ENVIRONMENT

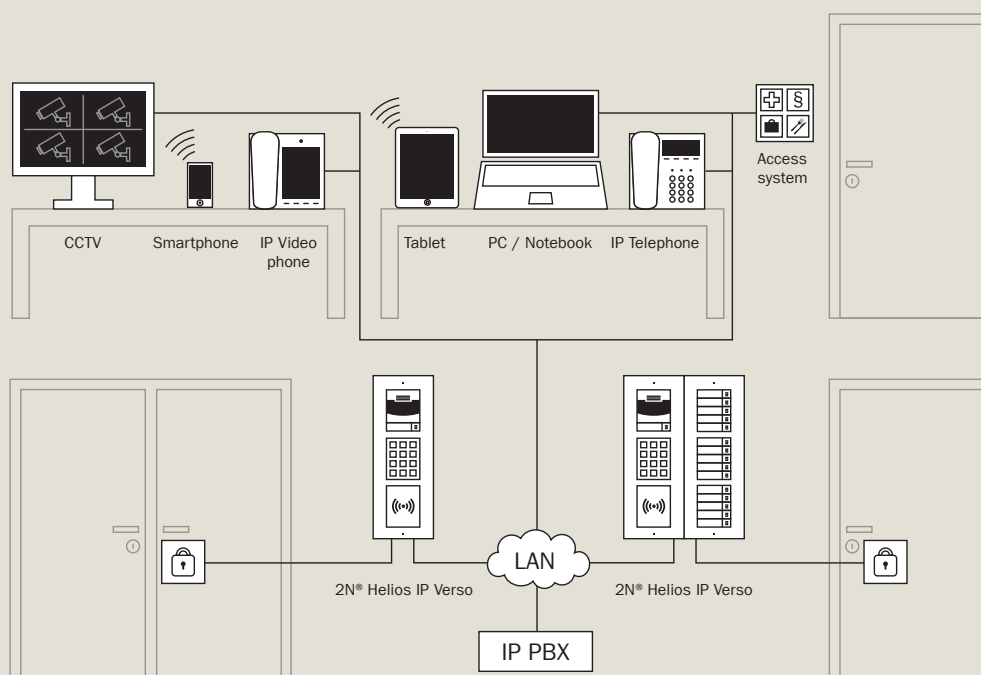

The high modularity of our device means that you can choose the solution that suits your needs. As a rule, you will need a HD camera at the entrance door, a smartcard reader and a key pad for entering access codes. At an operational entrance, you will certainly want to add employee name tags and the names of individual departments. You don't have to worry about not having enough space – the 2N® Helios IP Verso is capable of serving up to 146 name tags at once. Integration with your existing CCTV system or connection to the telephone switchboard for further functions goes without saying.

IP ENVIRONMENT

2N® Helios IP Vario



SUGGESTED USES



Picture from the door to the telephone

The video is easily displayed from an intercom on a mobile phone or tablet



Attendance system

The intercom can also serve as a terminal for an attendance system of all your employees

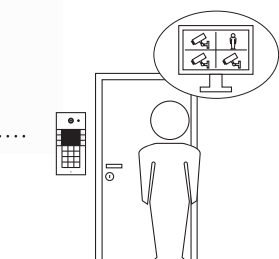

Connection with CCTV

You can easily send the video from the intercom to the camera system



ONVIF



BOSCH AVAYA

Alcatel-Lucent



RECOMMENDED USE

Office buildings

Every office building needs to resolve the problem of security at the entrance, allowing employees access and also greeting visitors in a dignified manner. It's also good to think of an attendance system for individual employees and possible connectivity with the existing telephone system. The beauty of the technology is most evident as soon as you let a visitor in using your tabletop telephone, mobile or tablet. Thanks to the integrated camera you not only see who you are talking to, but for the purposes of greater security 2N® Helios IP Vario can also send a photograph of a visitor to an email address or connect up to your camera system using the ONVIF® protocol.

Main advantages:

- Control of entry to the building (card, code)
- Attendance system for employees
- Voice and picture on regular tabletop telephone
- Camera with possibility of connection to CCTV
- Colour display with telephone list

Public and commercial buildings

Whether it's a government building, museum, school, library or shopping centre, it is necessary to keep both people and property safe. 2N® Helios IP Vario is a device which can secure the entrance, monitor visitors using the built-in camera and at the same time cooperate with the camera system. It helps people find their way around in public spaces, prevents the movement of unauthorised people or seals off protected areas. Even challenging customers such as large shopping centres will appreciate the great design and possibilities of video. Moreover, thanks to the RFID reader, 2N® Helios IP Vario can be used to create an attendance and access system using a single device.

Main advantages:

- Smart design with backlighting
- Camera with possibility of connection to CCTV
- Control of entry to the building (card, code)
- Attendance system for employees
- Mass communications via intercoms over the internet

Residential area

A safe entrance to the home is a basic precondition for peaceful sleep and, if we add to this the possibility of taking a call on a telephone or tablet and a luxurious appearance, we have the ideal solution for your house. A 2N® Helios IP Vario on your gate will call your mobile phone, including a picture from the built-in camera – so you will see whether a family visitor or an uninvited guest has come to visit you. Moreover 2N® Helios IP Vario will send a photograph of the visitors who called when you were out directly to an email address or will simply connect up with your camera system and allow you to see who was at your door.

Main advantages:

- Receipt of voice and video on mobile telephone or tablet
- Sending of photographs to email address
- Camera with possibility of linking to home CCTV (camera) system
- Control of other equipment (lights, garage doors)
- Connectivity with home automation systems

EXAMPLE OF CONNECTION OF 2N® HELIOS IP VARIO IN OFFICE ENVIRONMENT

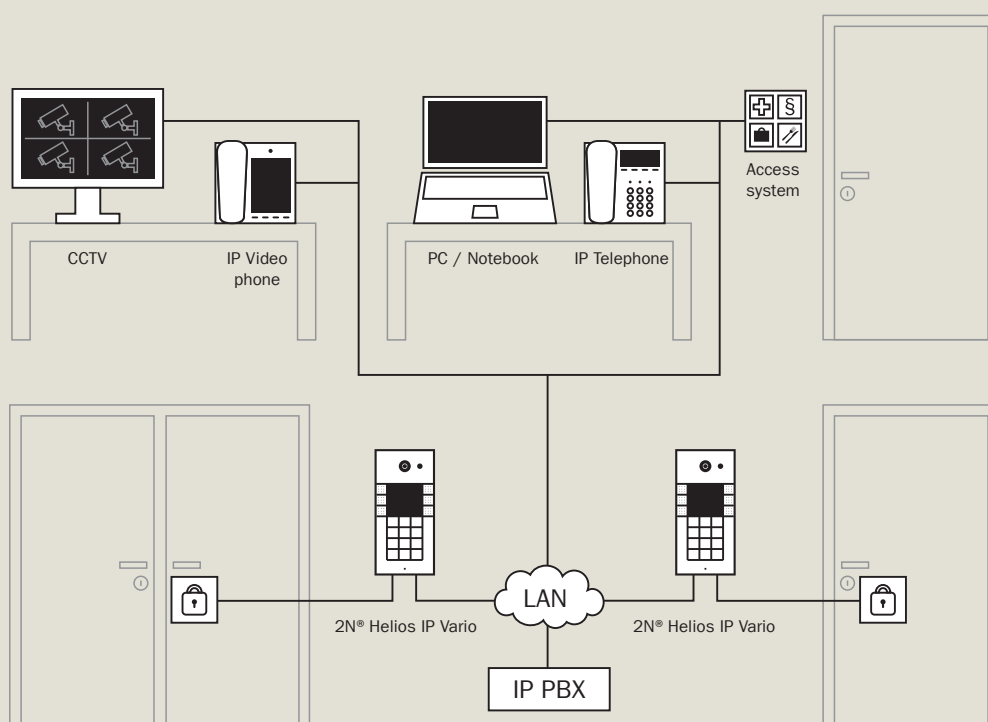

In an office environment it is possible to connect 2N® Helios IP Vario with any IP equipment. In this way it can function as part of the attendance system or CCTV system. The video from the intercom can be displayed very easily on an IP video telephone, notebook or tablet. You can easily integrate the intercom into the existing IP infrastructure.

IP ENVIRONMENT

2N[®] Helios IP Force



SUGGESTED USES

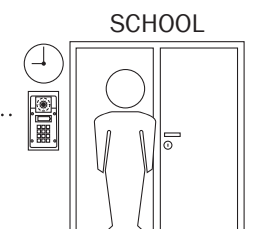

Security of school buildings
The time lock in the intercom can serve for the automatic closing of school entrances

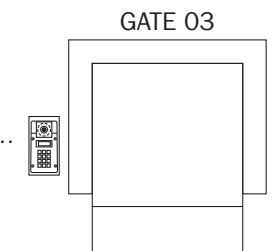

Protection of logistics inputs
In logistics centres no goods ramp remains unsupervised

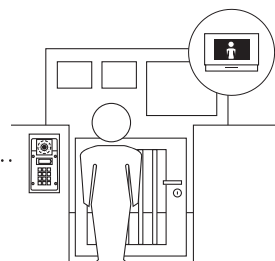

Home guard
The robustness and possibility of video make this intercom a suitable entry guard



RECOMMENDED USE

Office buildings

Securing the entry to an office or an entire office building is no easy matter. Vandalism can occur on a daily basis and unauthorised entries of persons and theft are relatively common. It is necessary to protect against this. 2N® Helios IP Force lets you control who has access to the office, for example using a numerical keypad or RFID reader. Events in front of the doors can be monitored using wide-angle video cameras and they will notify you of any unusual circumstances to you, either via email or in combination with the camera (CCTV) system. All of this and more is in a cast aluminium casing resilient to the weather and vandalism.

Main advantages:

- Resilience to ingress of dust and water (IP up to 69K) and to vandalism
- Voice and video on regular telephone
- Wide-angle colour camera with connection to CCTV
- Control of entry to the building (card, code)

Public and commercial buildings

Airport, government building, power station, shop floor – wherever it is necessary to ensure maximum security and control of people's movement. And it is also necessary for equipment such as an intercom to be resilient to the weather and to vandalism. As the most robust IP intercom on the market, 2N® Helios IP Force is resilient to bad weather and vandalism and it also has the function of access control via RFID cards, checking the attendance of employees or connection with the security system and camera system.

Main advantages:

- Highly robust aluminium cover in vandal-proof version
- Control of entry to the building (card, code)
- Wide-angle colour camera with connection to CCTV
- External power source or power over ethernet

Schools

In addition to passing on knowledge to your children, every school must try to ensure that our children are safe. There is perhaps no worse image than a strange person with bad intentions wandering around a school corridor. To make sure that such situations do not occur there is 2N® Helios IP Force. A door guard which ensures that no-one is allowed into school during teaching hours. A visitor must ring the operator, who sees him on the monitor, and he is also recorded by the camera system. Teachers and staff will also appreciate the integrated card reader, which not only lets them into the school at any time, but also records their entry and exit in the attendance system.

Main advantages:

- Wide-angle colour camera with connection to CCTV
- Control of entry to the building (card, code)
- Attendance system
- Resilience to ingress of dust and water (IP up to 69K) and to vandalism

Residential projects

The entrance to a house is a sensitive area – not only does it welcome you and your visitors, but it must also deter criminals, uninvited visitors and vandals. 2N® Helios IP Force is a great solution for a safe and also representative entrance. Using its wide-angle camera with night vision, it allows you to monitor events in front of your door. Moreover 2N® Helios IP Force offers you security functions such as the sending of visitors' photographs to an email address, connection to the door lock, or ability to reach you on a mobile telephone or tablet. All of this in a cast aluminium body resilient to the weather, dust and water and any vandalism.

Main advantages:

- Sending of photographs to email address
- Highly robust aluminium cover in vandal-proof version
- Wide-angle colour camera with night vision
- Connectivity with home automation systems
- Control via mobile telephone or tablet

EXAMPLE OF CONNECTION OF 2N® HELIOS IP FORCE IN HOUSE

A secure apartment complex is a suitable environment for the installation of a robust 2N® Helios IP Force intercom. At the gate it can withstand the attacks of vandals, dust and water. Easily connected to building's existing infrastructure provides an immediate overview of what is happening at the entrance. It can be connected with security company's control centre or camera system. Moreover the video from the intercom can be transferred to a home automation

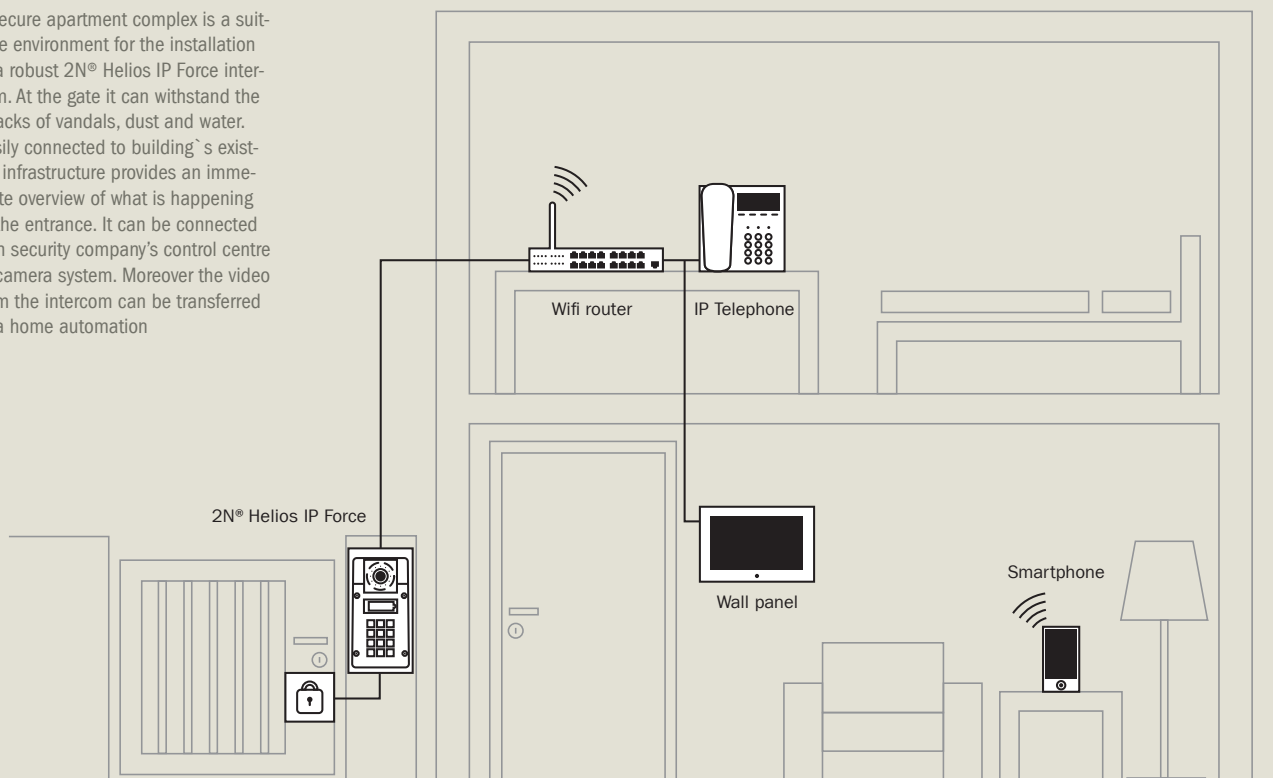

IP ENVIRONMENT

2N[®] Helios IP Safety



SUGGESTED USES

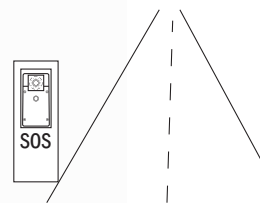

SOS point
 Suitable for installation on a motorway for the drivers' emergency communication with a control centre.

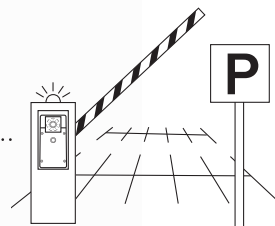

A highly visible aid in a car park
 Installed at the exit, it serves as an aid in unexpected situations

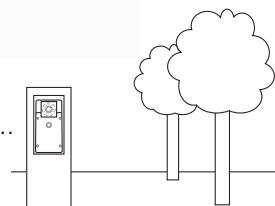

Infopoint in town park
 A visible and easy to operate Infopoint in a town park, relax zone or other place



BOSCH AVAYA

Alcatel-Lucent 

RECOMMENDED USE

Office buildings

Modern office buildings tend to have extensive underground car parks, where there can be accidents or thefts, where fires can break out or where other crisis situations can occur. You need a device which will simply and quickly put you in contact with remote assistance. We have developed 2N® Helios IP Safety precisely for these needs. You can see its bright orange colour from a long way off, and the backlit buttons will show you clearly just what you have to do even under poor visibility conditions. Moreover, it is made of robust cast aluminium, which is resilient to water and vandalism. Whenever you press its button, it will connect you with assistance, and its powerful speaker will tell you clearly and comprehensively just what to do, even in the noisiest of environments.

Main advantages:

- Striking orange colour
- Backlit emergency button
- High-quality audio
- Robust aluminium cover

Public and commercial buildings

School playground, town park, underground garage or even a motorway – unfortunately you can be in an accident, a victim of an attack or simply get into difficulty in any of these places. In such a case your orange guardian in the form of 2N® Helios IP Safety is there for you. This system provides immediate connection with assistance under any conditions. And it doesn't matter if it is flooded with water or the temperature is – 30 °C. In both cases it is fully functional. Moreover, thanks to its advanced functions and connection to IP it can activate a camera system or sound an alarm at any time if necessary. For you this means that you are just a push of a button away from help in any situation.

Main advantages:

- Control of camera systems
- High-quality audio
- Resilience to water and cold
- Striking orange colour

Motorway

Without activated roaming, a broken-down car on a motorway abroad can be an unexpected problem. At such a moment you will appreciate immediate help from a 2N® Helios IP Safety intercom used as a motorway SOS communicator. You can always rely on this system, even if exposed to extreme temperatures, weather or vandalism. And if it is damaged, or there is an attempt to break into it, it immediately informs the motorway servicing personnel of this, and they can ensure redress immediately.

Main advantages:

- Very powerful speaker for noisy environment
- Tamper switch for detection of violent ingress
- Resilience to ingress of dust and water (IP up to 69K) and to vandalism
- Illuminated resilient button for simple operation

EXAMPLE OF CONNECTION OF 2N® HELIOS IP SAFETY ON MOTORWAY

2N® Helios IP Safety can be connected to the emergency communication system on a motorway. The advantage is connection to data circuits which generally run along motorways. After pressing the button the caller is immediately connected with the control centre, and he is given the help he needs.

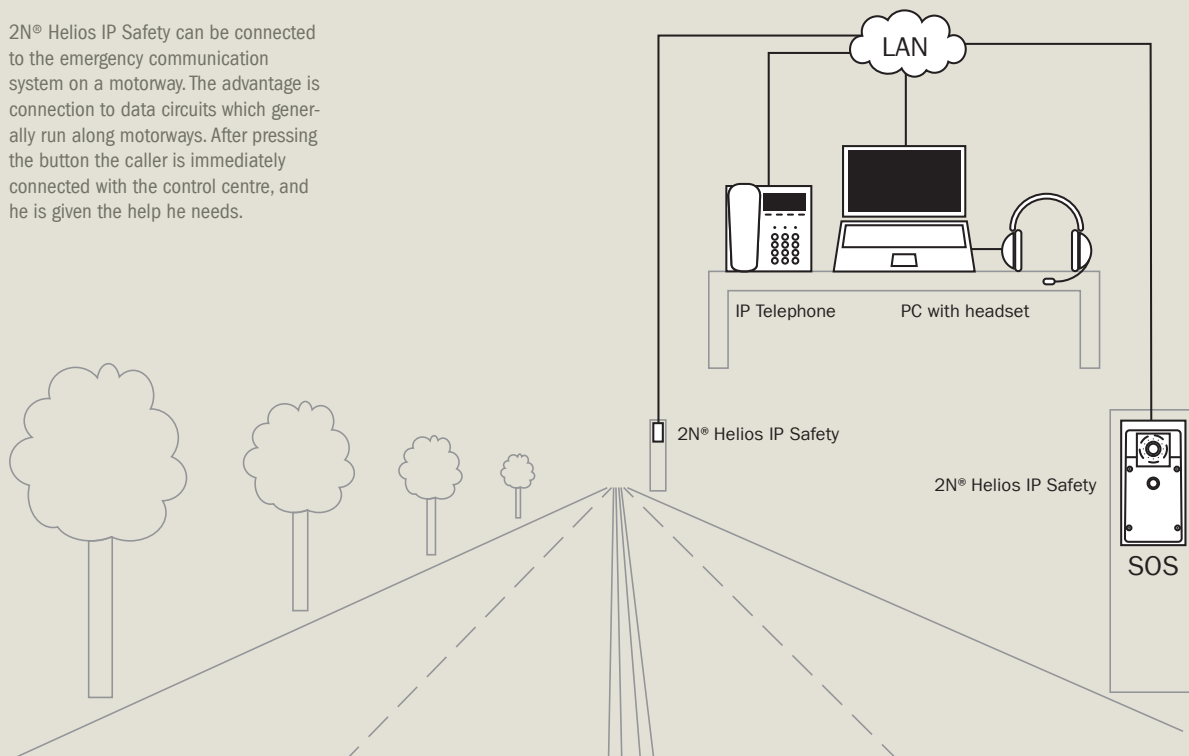

IP ENVIRONMENT

2N[®] Helios IP Uni



SUGGESTED USES

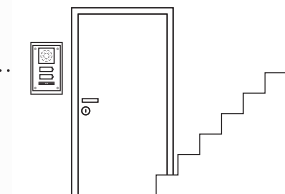

Simple communication at office
 Rear stairway at an office where it is necessary to ensure safety and also easy operation.

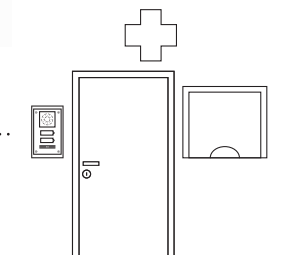

Intercom for night pharmacy
 A simple and effective system for calling the personnel to the serving hatch of a night pharmacy



BOSCH AVAYA

Alcatel-Lucent 

RECOMMENDED USE

Office buildings

Most office buildings have many places such as rear or goods entrances, fire escapes or entrances within the building which should remain closed, and where authorisation is necessary for access. The ideal solution in this case is 2N® Helios IP Uni. This IP intercom is a simple device allowing the reliable connection and control of doors. So for example, when they bring the post to the goods entrance tomorrow, it's possible that postman got to you with the help of the 2N® Helios IP.

Main advantages:

- Simple installation in existing IP infrastructure
- Alarm in case of tampering
- Web interface
- Tool for central administration

Public and commercial buildings

It is very easy to get lost in buildings such as hospitals, museums, schools or government offices, or simply not to know which door leads to the right doctor or clerk. The 2N® Helios IP Uni is especially for these cases; an intercom which can be installed easily in any place. In a moment it will connect you with the receptionist and thus ensure professional help for you. The location of the person taking the call is irrelevant, because with VoIP communication the call can be routed not only to a tabletop telephone, but also a mobile phone or DECT appliance in the building.

Main advantages:

- VoIP communication
- Simple installation
- Utilisation of existing LAN/WAN network

EXAMPLE OF CONNECTION OF 2N® HELIOS IP UNI IN SHOPPING CENTRE

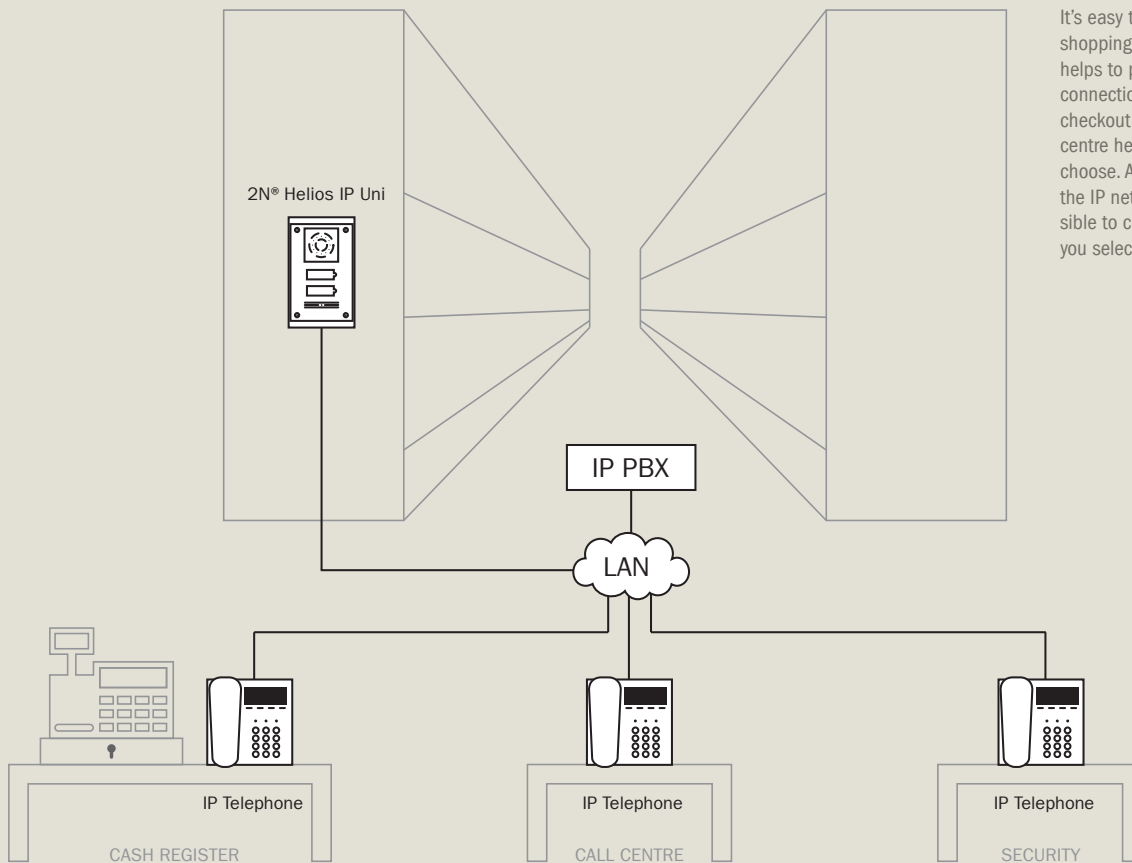

It's easy to lose your way in a shopping centre. 2N® Helios Uni helps to provide an immediate connection with security, a checkout operator or control centre here. You just have to choose. All of this happens over the IP network, and so it is possible to call on any device which you select during installation

IP ENVIRONMENT

2N[®] Indoor Touch



SUGGESTED USES

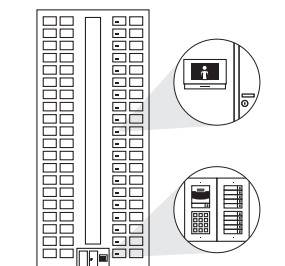

Residential building

An internal unit, which you can use to operate the entry door even if it is 25 storeys below you, can be placed in each apartment.



Luxury home

For your luxury furnished flat or house, you can use it as a terminal for monitoring what is happening at your door; including video.

RECOMMENDED USE

Residential area

Everyone wants to surround themselves with only beautiful things in the comfort of their own home. Whether it's furniture, electronics or other accessories, we simply want to have nice things around us. So, we've come up with the ideal accessory for 2N® Helios IP intercoms for residential installations in the form of a touch panel that receives video calls and controls the door lock. But it's not just its clean lines and modern design, together with the large touch screen that makes the 2N® Indoor Touch unique. You see, as a bonus it offers the option of connection to IP cameras, from which it can display video during the call and even after the end of the call. This means you can look to see if your children are still playing in the garden, or if the postman left the parcel by the garage door, as you asked him to over the intercom.

Residential buildings and condominiums

Residential complexes or residential buildings with twenty storeys, all places where dozens of families live and want to see and hear who is coming to visit them or why they are ringing their doorbell. No one wants to take the lift twenty storeys down or run a kilometre to the entrance every time a visitor or postman rings. Why not simply let the occupants take a video call from the entrance to ask the postman from a distance to leave the package with the concierge and arrange it with him directly via the terminal, or open the door and use the video to tell a visitor where to find you, or invite your neighbour to a barbecue, or configure the do-not-disturb „DND” mode at night? All of this can be configured easily on the great-looking 2N® Indoor Touch communicator, which, thanks to its elegant black finish and stylish glass touchscreen panel, will fit in with the interior decor and become a design accessory for your household. 2N® Indoor Touch uses the Android operating system like today's tablets and is prepared

for the installation of other home automation components. So after coming to an agreement with an intelligent household supplier, you can control of the blinds, air-conditioning, lights, underfloor heating and security system. Then you have everything in one place, on one touchscreen panel, which you can also connect up to the internet and so make it a central information point for the entire household.

Main advantages:

- 7" touchscreen with power saving mode
- Multicolour LED status indicator
- Receipt of HD picture from door intercom
- Two-way communication with other units in the network
- Display of missed calls, including photograph
- Setting of Do not Disturb – “DND” – mode
- PoE power or via external power source
- Android operating system
- Simple control and configuration

EXAMPLE OF CONNECTION OF THE 2N® INDOOR TOUCH

You can fully operate the intercom at your gate from the comfort and safety of your own home. All you need is the 2N® Indoor Touch unit. The large display and simple controls ensure that whatever the weather and the circumstances, you will have a clear idea of what is happening at your door, but you won't need to go out to see.

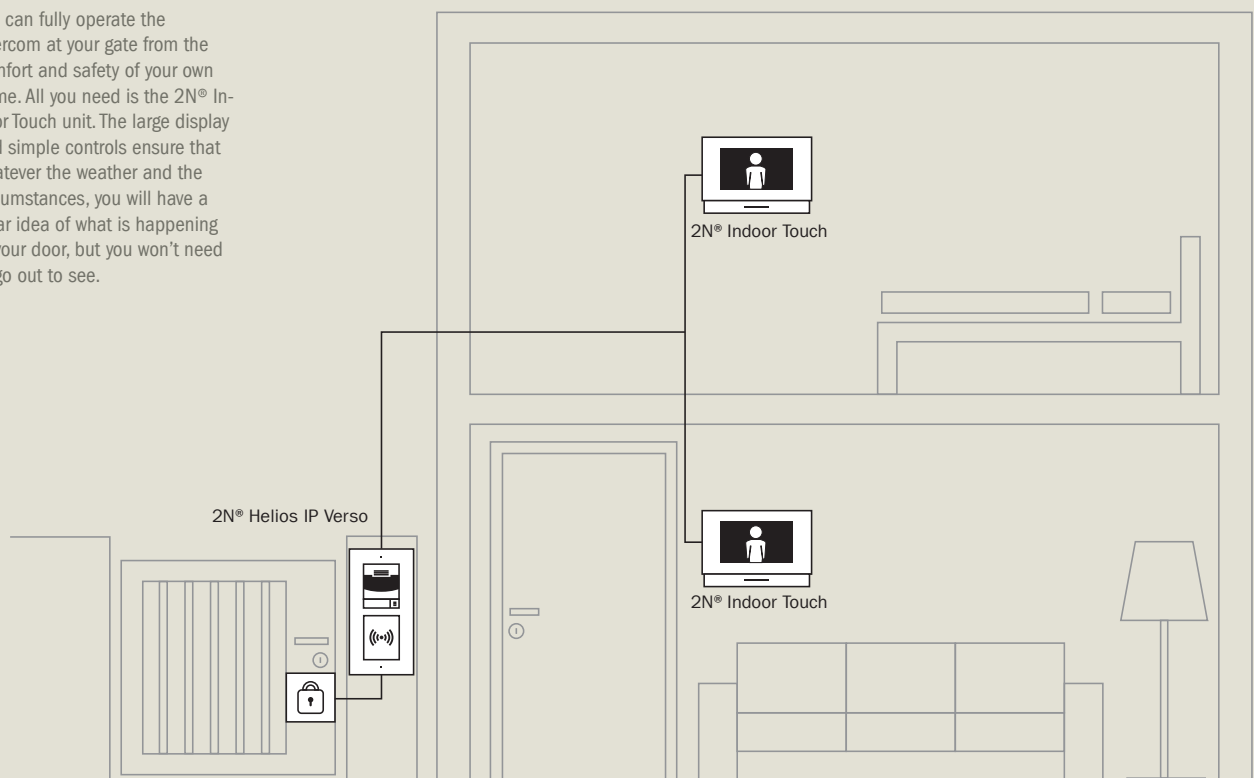

IP ENVIRONMENT

2N[®] NetSpeaker



SUGGESTED USES

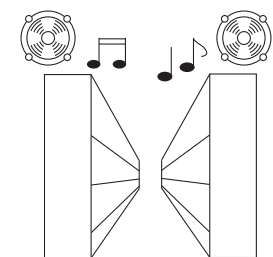

In-store audio in shopping centre
Play background music and advertising messages in individual departments in a selected shop

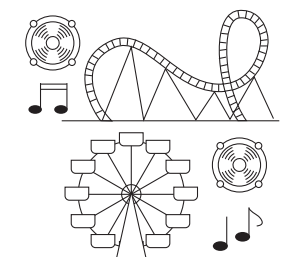

IP audio at theme park
For each attraction it is possible to play various sounds or broadcast important information without having to announce it to the entire park

RECOMMENDED USE

Commercial sector

Listening to pleasant music has become an integral part of our leisure time, whether we spend our time actively in sports centres, or passively in relaxation centres or restaurants.

Each building of this type needs to resolve the question of how to provide an audio solution for various zones and at the same time have the possibility of playing a different type of music or spoken word audio to each of them. Easy operation from one place (usually reception) and the possibility of control within the context of the given zone are basic requirements.

The IP Audio system 2N® NetSpeaker uses existing structure cabling or Wi-Fi cover and so does not require the laying of audio cables. It is the ideal solution for small restaurants, hotels, bars, fitness and wellness centres, saunas, squash centres and various types of gym because it allows the supply of music and

audio advertisements at the given time, the broadcasting of recorded messages and the announcement of information using a microphone.

Thanks to the native integration of the SIP protocol it is possible to use the entire system not only to play background music, but also for connection with an IP PBX for active announcements to the individual zones from any telephone.

Main advantages:

- Up to 100 independent zones
- Support of internet radios
- Installation on common structured cabling (Cat 5)
- Easy operation using PC, tablets, mobile phones or remote controller
- Possibility of connection to IP PBX and announcements for individual zones from telephones
- Possibility of wireless connection of speakers using Wi-Fi

Centralised PA in remote localities

We may not even notice the background music or adverts which accompany us virtually every time we go shopping, but renowned marketing studies state that audio advertising influences us when we select goods. Retail chains are trying to find a way to centralise the broadcasting of background music and advertising to all their branches throughout the entire country. The audio solution in each shop is generally realised separately (using 100V PA systems or evacuation centres) without central administration. The IP Audio system 2N® NetSpeaker is an ideal solution for connecting audio over the data (IP) network of all branches and their traditional audio systems. The system allows zoning, and as a result it is possible, for example, to broadcast background music and also react flexibly and inform the public about sales, which can differ in the various regions.

Thanks to the native integration of the SIP protocol it is possible to use the entire system not only to play background music, but also to connect with an IP PBX for active announcements to the individual zones from any telephone.

Main advantages:

- Up to 10000 branches
- Up to 1000 zones
- Simple administration of background music and advertisements
- Online monitoring of all units
- Online reporting about music played
- Possibility of playing backup content from SD card in the case of a failure in data connectivity
- Possibility of connection to IP PBX and announcements for individual zones from telephones (including mobile telephones)

EXAMPLE OF CONNECTION OF 2N® NETSPEAKER IN WELLNESS CENTRE

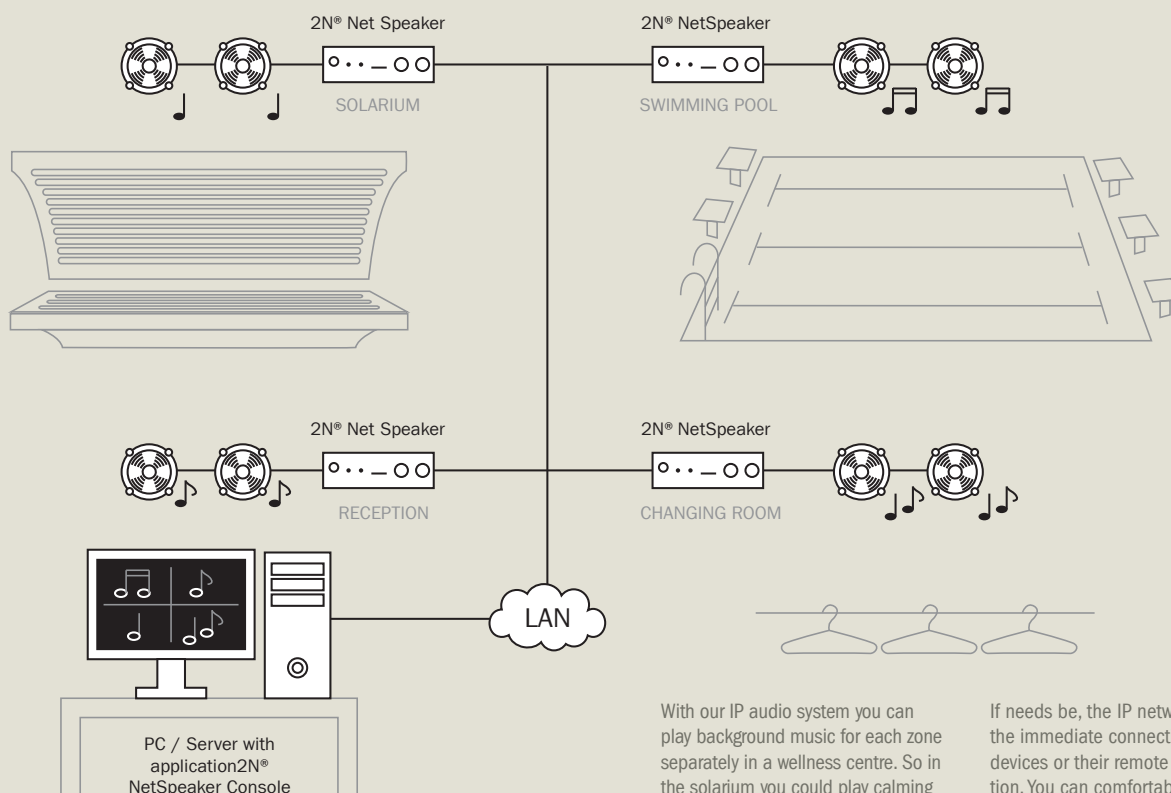

With our IP audio system you can play background music for each zone separately in a wellness centre. So in the solarium you could play calming classical music; meanwhile in the pool where there is a water polo game going on you will hear a medley of rock song.

If needs be, the IP network serves for the immediate connection of other devices or their remote administration. You can comfortably control everything from one computer thanks to the supplied software.

IP ENVIRONMENT

2N[®] SIP Speaker



SUGGESTED USES

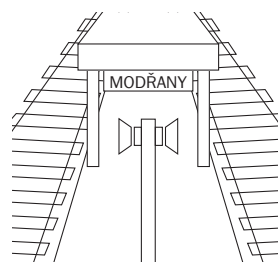

Public announcements at railway station

Simple connection of audio with existing exchange for announcements at metro, train and bus stations

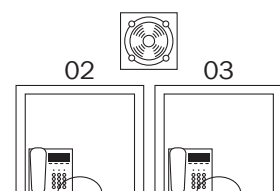

Announcement at public offices

Every clerk has a telephone on their desk and can use it to make any announcements of important information to those visiting the office

RECOMMENDED USE

Warehouses, waiting rooms, remote sites

In warehouses or waiting rooms there is a need to make loud announcements – typically to report a new order or call another patient. This need has also arisen in remote sites such as transformer stations or the base stations of mobile operators. Although they are fenced off and monitored by cameras, experience has shown that not even these measures deter unwelcome visitors from these buildings. Although the security operative can see that an intruder has entered the object, before he can get to the scene the intruder is usually gone. Experience has shown that verbal warning information is far more effective if combined with visual information (the security operative can announce: “You in the blue turtleneck, I can see you!”)

2N® SIP Speaker allows remote announcements to be made to any places where there is a data network, and it exists in two variants. As a separate unit, which you can connect to any external speaker (4-8 Ω) or as a ready solution, i.e., directly built into the 2N speaker.

Main advantages:

- Powerful built-in amplifier
- Universal input/output – external sensors may be connected
- Installation on common structured cabling (Cat 5 and higher)
- Input for external microphone
- Warehouses, waiting rooms, remote sites
- Power supply via PoE or adapter

Office buildings

Do you need to ensure easy announcements from IP telephones in the PA exchange? There used to be a private branch exchange (PBX) installed in each office building in order to save on costs and because of the services which helped make work more effective. These days the traditional analogue exchanges have most often been replaced by IP exchanges (IP PBX) or even the Centrex operator service (virtual exchange), i.e., a service where no HW is installed on the customer side, only IP telephones. Most office buildings also have a PA exchange installed. So that a customer can use his own telephone for announcements, PA exchanges have been connected to telephone exchanges using so-called audio/relay cards. But these cards are generally

supported by new IP exchanges, and certainly not by virtual exchanges. And this is resolved by 2N® SIP Speaker, which serves as a simple converter between the IP exchange and traditional PA exchange and so allows easy announcements from IP telephones or even from mobile telephones.

Main advantages:

- Support of all virtual and IP exchanges
- Power supply via PoE or adapter
- Installation on common structured cabling (Cat 5 and higher)
- Easy installation via web menu

EXAMPLE OF CONNECTION OF 2N® SIP SPEAKER IN CONNECTED WAREHOUSES

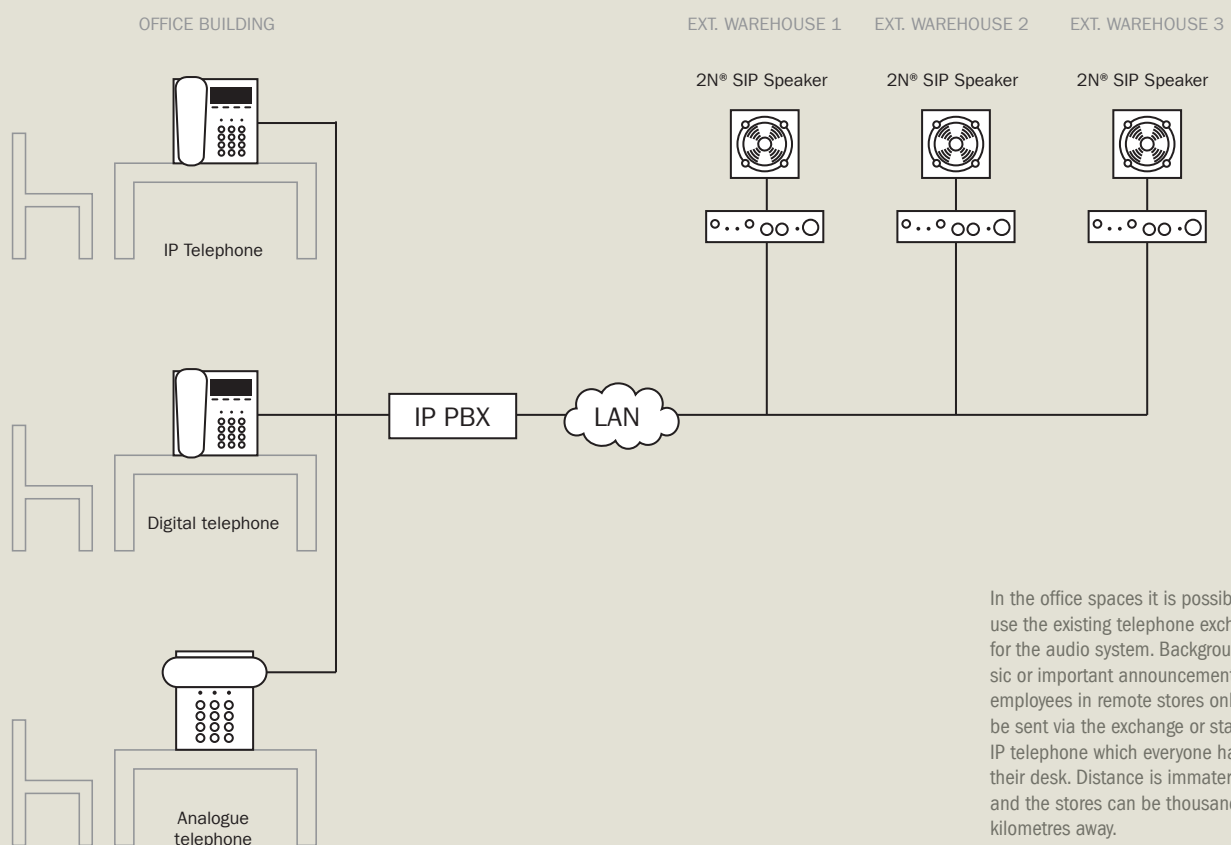

In the office spaces it is possible to use the existing telephone exchange for the audio system. Background music or important announcements for employees in remote stores only need be sent via the exchange or standard IP telephone which everyone has on their desk. Distance is immaterial, and the stores can be thousands of kilometres away.

IP ENVIRONMENT

2N[®] NetMic



SUGGESTED USES

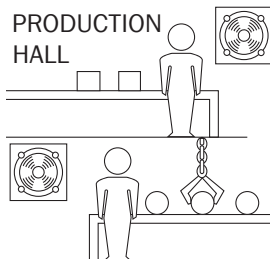

In production halls
Can be used to control operations by playing recorded or live announcements when necessary



In shops and entertainment centres
Can be used both for playing recorded announcements or live broadcasts

RECOMMENDED USE

Shops and entertainment facilities

In every shopping and entertainment centre, it is necessary to make a live or recorded announcement from time to time. This announcement can be made universally (through all speakers) or specifically (to specific zones). The 2N® NetMic enables both live and recorded announcements to any desired zone. Operating staff simply select the chosen zone(s) by pressing a button and can start talking, or play a pre-recorded message. Thanks to status indicators for the given zone (stand-by = you can speak, busy = a different announcement is being made in that zone), the operator cannot interrupt an announcement being made. The 2N® NetMic uses the existing structured cabling or Wi-Fi signal and so

needs no audio cable installation. It is an ideal solution for shopping, entertainment and wellness centres or various types of gym. It is the ideal accessory for the 2N® NetSpeaker IP Audio system, which enables music to be broadcast and recorded advertisements to be played at set times.

Main features:

- Audio broadcasting to the zone(s) of your choice
- Listening in to audio announcements in various zones
- Ability to connect anywhere in the network (IP solution)
- Simple and convenient operation (even without a computer)
- Simple configuration via the 2N® NetSpeaker Control Panel app

EXAMPLE OF CONNECTION OF THE 2N® NETMIC

In an emergency, this can be used to report a lost child, for instance: "A small child has been found near the ice-cream stand. He/ she is well. Would his/ her parents please come and

pick him/ her up from the information centre." The announcement is first sent to a specific zone, and if five minutes goes by without a response, the announcement can be sent to all zones.

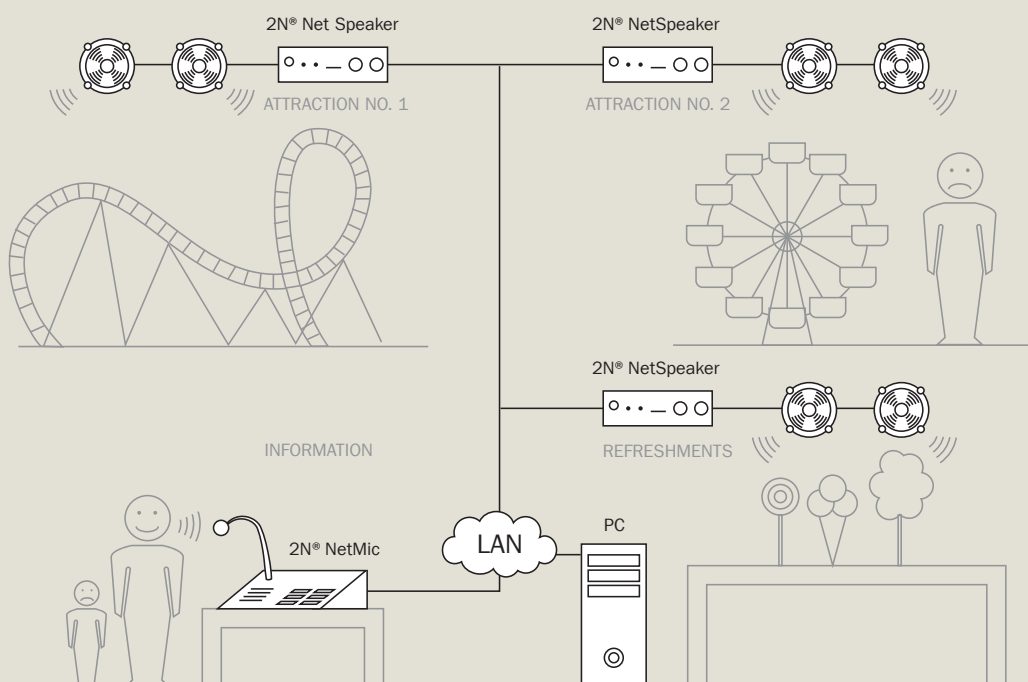

Solution for analogue environment

Analogue technology today tends to be associated with outdated devices. But in telecommunication technology there are still many devices which use this technology due to its simplicity and undemanding nature.

In 2N we have more than 20 years experience with the development of analogue telecommunication technology, and we are constantly trying to improve our analogue products so that they provide the greatest utility in spite of the simplicity of their interface.

CONNECTIVITY IN ANALOGUE ENVIRONMENT

Thanks to open standards analogue intercoms from 2N can be connected with a wide range of external devices:

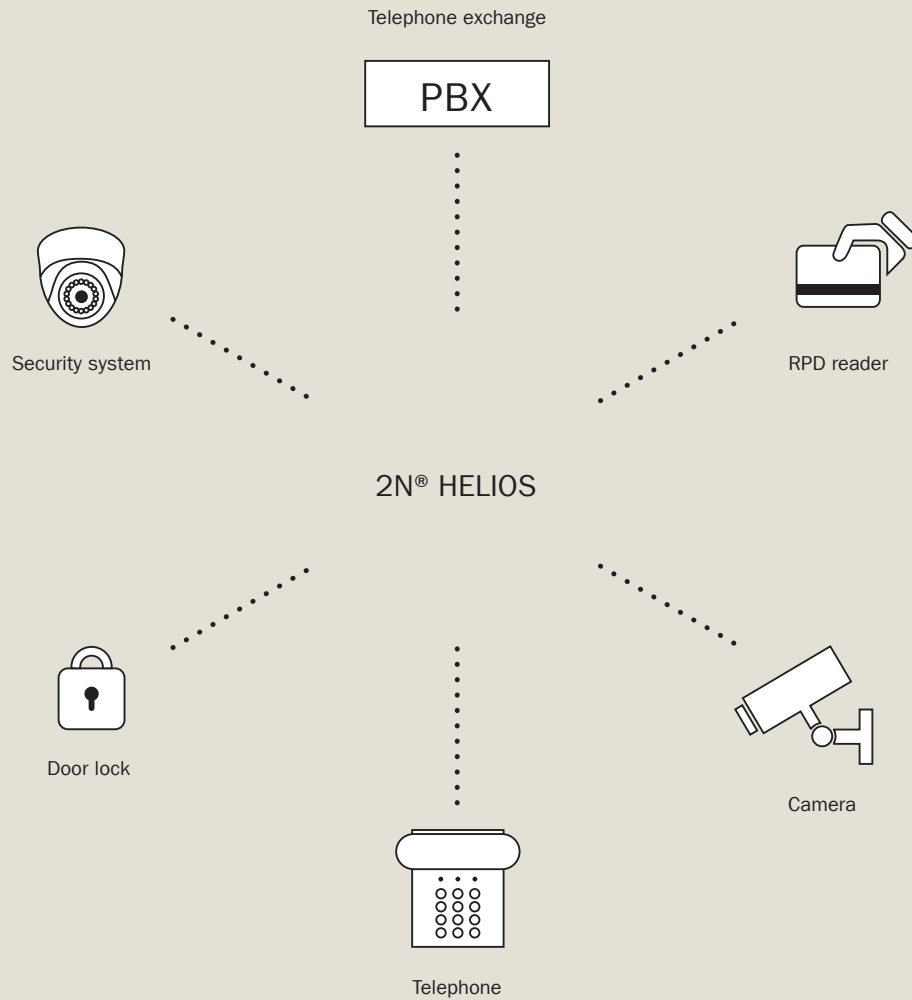

This led to the creation of the 2N® Helios group of intercoms, which offers their users the best of the current technology of analogue communication exchanges.

ANALOGUE ENVIRONMENT

2N® Helios Vario



SUGGESTED USES

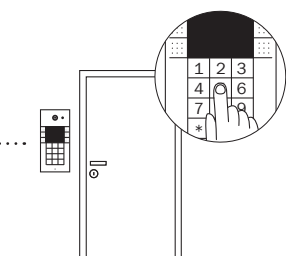

Code controlled entry

In the analogue environment of an office an intercom can serve for code-based entry

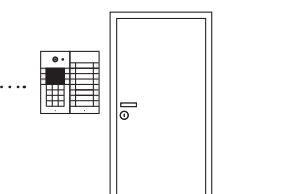

Entry to apartment building

Can be expanded up to 54 buttons therefore suitable for large apartment blocks

RECOMMENDED USE

Office buildings

Every office building needs to resolve the security of its entrance, allowing employees access and also greeting visitors in a respectable manner. 2N® Helios Vario is a unique solution for an office building equipped with an analogue PBX, which can be connected to easily and which makes it possible to call individual employees. The camera can send a picture to the camera system or monitor and so improve the overview of movement at the entrance. Another advantage for office buildings is the possibility of integrating an RFID card reader in the intercom and thus simplifying access for employees.

Hlavní přednosti:

- Up to 54 physical buttons
- Checking access to the building (coded)
- Colour camera
- Voice on regular table-top telephone
- Remote administration of intercom over regular telephone line

Public and commercial buildings

Government offices, schools, shopping centres and libraries are all places where you can find an analogue PBX. If under these conditions you need to install an intercom to check entry and communication with visitors, 2N® Helios Vario is the right solution for you, and it comes in a smart stainless steel finish. And using the built-in camera 2N® Helios Vario also allows you to display the events in front of the door on a monitor or send the picture to a camera system and so contribute to greater security of the object.

Hlavní přednosti:

- Smart design with backlighting
- Camera
- Up to 54 physical buttons
- Checking access to the building (coded)

Residential area

Many houses today have a small PBX for home intercoms. 2N® Helios Vario represents an ideal addition for ensuring safety and comfort for users and visitors. A call from 2N® Helios Vario can be taken on a telephone within the house, and you can open the door for a visitor at the touch of a button. 2N® Helios Vario may also be equipped with a video camera module which can send a picture to a monitor at the door or directly to your camera system. So in combination with a mobile telephone you can control your doors from anywhere.

Hlavní přednosti:

- Camera with possibility of linking to CCTV (camera) system
- Control of other equipment (lights, garage doors)
- Twin-wire analogue connection to existing exchange
- Checking access to the building (coded)

EXAMPLE OF CONNECTION OF 2N® HELIOS VARIO IN AN ANALOGUE OFFICE ENVIRONMENT

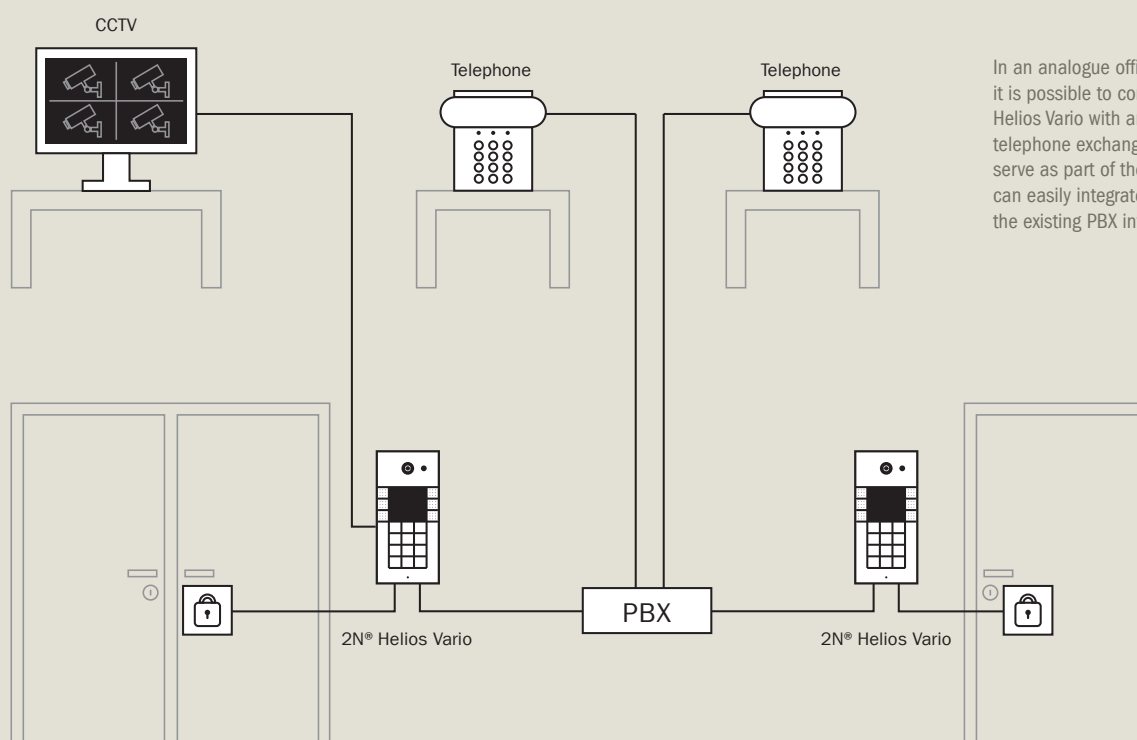

In an analogue office environment it is possible to connect a 2N® Helios Vario with any equipment via a telephone exchange. In this way it can serve as part of the CCTV system. You can easily integrate the intercom into the existing PBX infrastructure.

ANALOGUE ENVIRONMENT

2N[®] Helios Force



SUGGESTED USES

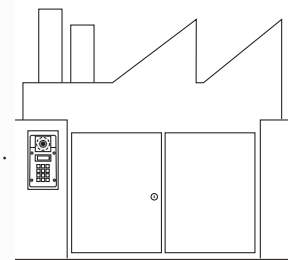

Vehicular entry to industrial complex

It protects extensive industrial complexes where the deployment of IP technology is not possible.

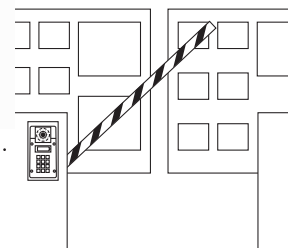

Vehicular entry to residential complex

For large residential projects with a need for robustness and security

RECOMMENDED USE

Office buildings

2N® Helios Force is at home wherever it is necessary to allow comfortable communication for visitors and to have the opportunity to open the door to them from reception or from another place. Many office buildings still use analogue PBXs, and these are an ideal environment in which to use 2N® Helios Force. Its resilient aluminium alloy body and integrated amplifier ensure reliable communication under adverse conditions, and thanks to the keypad version it is possible to use it as an access system via numerical codes.

Main advantages:

- Highly robust aluminium cover in anti-vandal version
- Highest resilience on the market according to standard IP65
- Twin-wire analogue connection to existing exchange
- Checking access to the building (coded)

Public and commercial buildings

Entrance protection is an important theme in all types of commercial buildings, be they shopping centres, spas or government offices. But what can one do if there is only an analogue exchange in these buildings, but you still need a robust entry guard? The solution is the 2N® Helios Force analogue intercom, which offers the best of analogue technology and maximum robustness thanks to the standard IP65. A powerful speaker, top of the range hands free set and great resilience ensures reliable communication and the possibility to control the entrance from any telephone in the building.

Main advantages:

- Powerful amplifier
- Highly robust aluminium cover in anti-vandal version
- Connection to existing analogue exchange
- Remote administration over regular telephone line
- Highest resilience on the market according to standard IP65

Industry

Even modern industrial operations suffer from dust, high temperatures and interference from powerful equipment. Another problem here is long distances, which make it difficult or even impossible to use IP technology. 2N® Helios Force, a resilient intercom intended for connection to an analogue exchange, is just ideal for such installations. Thanks to the simplicity of the analogue interface, it can be several kilometres away from the exchange and still provide a perfect voice. Modern body and because of the powerful integrated amplifier provides high volume output.

Main advantages:

- Integrated amplifier with function of bridging during power failure
- Operates from exchange only in case of a power failure
- Highest resilience on the market according to standard IP65
- Twin-wire analogue connection to existing exchange

EXAMPLE OF CONNECTION OF 2N® HELIOS FORCE IN AN INDUSTRIAL ENVIRONMENT

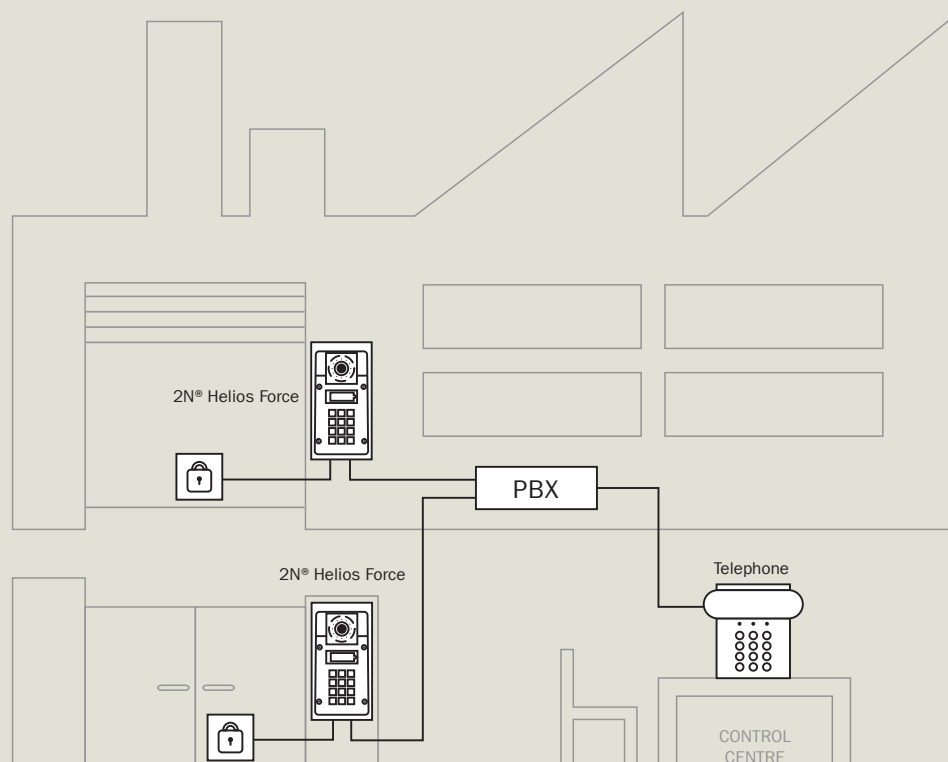

Industrial operations are usually equipped with an exchange, and the environment is analogue. In such a case the analogue 2N® Helios Force is suitable for securing entries and exits. At the gate it can withstand the attacks of vandals, dust and water. It can be connected with the control centre of the security service or camera system.

ANALOGUE ENVIRONMENT

2N[®] Helios Safety



SUGGESTED USES

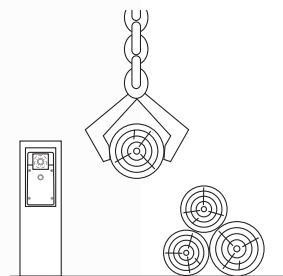

SOS in industry

A striking aid in distress for industrial complexes, where analogue technology is commonplace

PARKING

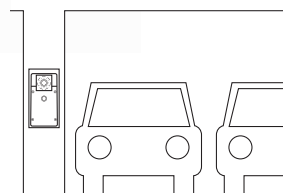

SOS in garages

Summon help easily in underground garages, even with reduced visibility

RECOMMENDED USE

Heavy industry

A foundry, rolling mill or quarry is a place where reliable communication is vitally important for the safety of workers. An intercom is exposed to dust, extreme temperatures or mechanical damage. 2N® Helios Safety, the most resilient analogue intercom, which is robust due to its solid aluminium body is robust and ensures communication under any conditions, was created for such conditions. An analogue interface is suitable here by virtue of its simplicity and it is possible to connect it several kilometres from the exchange. It offers a high volume output for even noisy environments.

Main advantages:

- Highest cover class (standard IP65)
- Striking orange colour for easy location
- Twin-wire analogue connection to existing exchange
- High volume and comprehensible

Public and commercial buildings

A school playground, town park, underground garage or even a motorway – you could witness an accident or attack or simply get into difficulty in any of these places. In such a case an orange guardian is here for you in the form of 2N® Helios Safety, which is intended for installation with an analogue line. So for example you can locate the communicator easily in a place even without telephone infrastructure because all analogue communicators, including 2N® Helios Safety can be combined with analogue 2N GSM gateways and so ensure safe communication really from anywhere.

Main advantages:

- Highest cover class (standard IP65)
- Robust orange cover in vandal-proof version
- Combination with GSM gateways
- Striking orange colour

EXAMPLE OF CONNECTION OF 2N® HELIOS SAFETY TO A PARKING SYSTEM

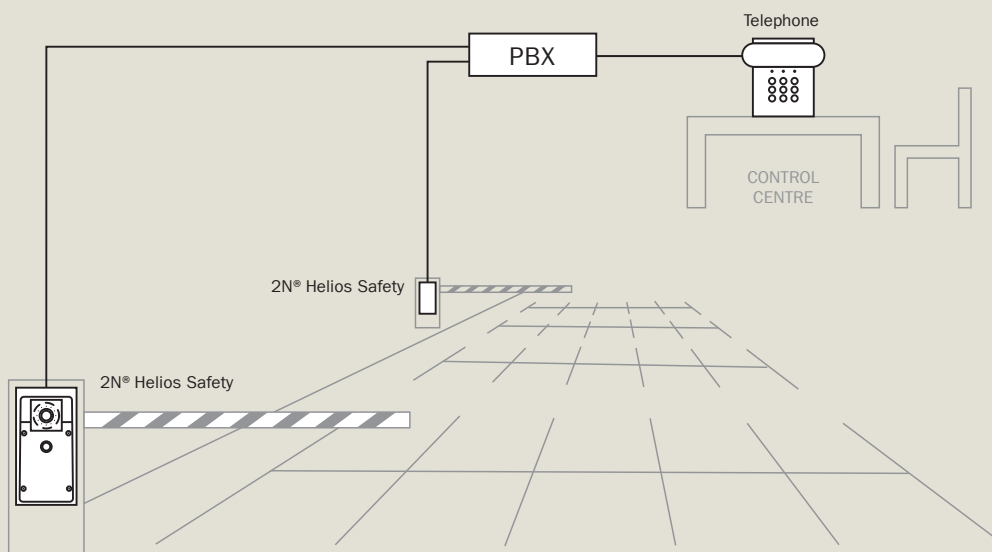

2N® Helios Safety can be connected to the emergency communication system on a car park or a shopping centre where a complete analogue environment has already been created. After pressing the button the caller is immediately connected via the existing PBX with the control centre, and he is given the help he needs.

ANALOGUE ENVIRONMENT

2N[®] Helios Uni



SUGGESTED USES

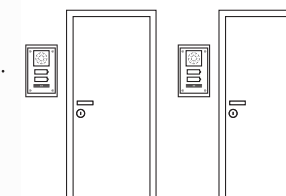

Communication at government office

Simple communication where an exclusive design or special function is not needed

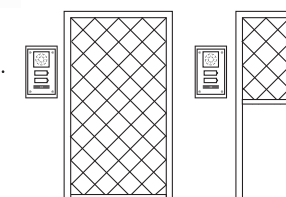

Communication in shopping centre

The communicator can summon assistance, security or another person

RECOMMENDED USE

For office buildings

Most office buildings have many places such as rear or goods entrances, fire escapes or entrances within the building which should remain closed, and where authorisation is necessary for access. And if an analogue exchange and analogue distribution wiring are used in the building, 2N® Helios Uni is the right solution. Its simple installation will save you time and money for installation and configuration using a voice menu that can be performed remotely by a technician. Naturally locks can be controlled using a telephone, 2N® Helios Uni is a perfect solution for your entry in an analogue technology environment.

Main advantages:

- Remote configuration over telephone
- Additional amplifier
- Power supply from analogue line
- Simple installation on existing IP infrastructure

For public and commercial buildings

You have probably had an experience where you couldn't find the right room in an institution, or you found yourself in a hospital, standing in front of a closed door that you had to get through. In such a situation you would definitely appreciate being able to call someone who could help you. And if an analogue telephone distribution system and exchange are used in such a building too, at a great price, 2N® Helios Uni is the perfect solution which allows you to communicate from anywhere and open the right door for you.

Main advantages:

- Simple installation
- Powered from existing analogue exchange
- Power supply from analogue line
- Remote configuration over telephone

EXAMPLE OF CONNECTION OF 2N® HELIOS UNI IN SHOPPING CENTRE

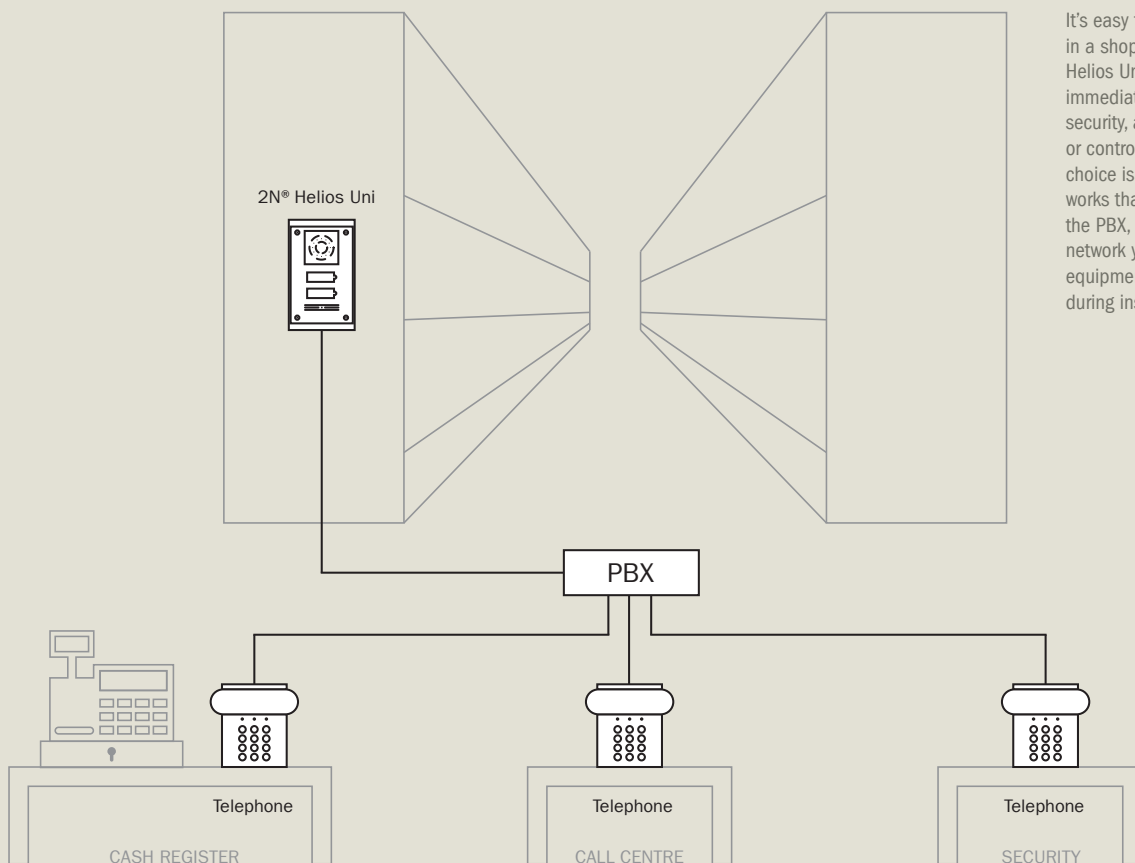

It's easy to lose your way in a shopping centre. 2N® Helios Uni helps to provide immediate connection with security, a checkout operator or control centre here. The choice is yours. Everything works thanks to connection the PBX, over the analogue network you can call any equipment which you choose during installation.

Even the smallest detail an important role ...

For the selection of an appropriate intercom you will find information here about its functions, versions and available equipment.



Selection

Functions of intercoms

IP ENVIRONMENT

2N® Helios IP

Security

- Integration into camera systems
- Sending photographs to email address
- Night vision (2N® Helios IP Force)
- HD camera with infrared light and night vision (2N® Helios IP Verso)
- Secure connection of lock
- Secure HTTPS communication
- Secured SIPs signalling
- Secure connection to network
- Event log
- RFID card reader (2N® Helios IP Verso, 2N® Helios IP Vario, 2N® Helios IP Force)
- Access control

Physical security

- Cover level up to IP69K (2N® Helios IP Force, 2N® Helios IP Safety)
- Antivandal version (2N® Helios IP Force, 2N® Helios IP Safety)
- Security screws (2N® Helios IP Force, 2N® Helios IP Safety)
- Tamper switch (2N® Helios IP Force, 2N® Helios IP Safety, 2N® Helios IP Uni)

Communication

- Calling via exchange
- Calling directly to telephone
- Calling to up to 3 telephones at once
- Substitute function
- Time profiles for calling
- Up to 2000 records in list
- "Telephone" function
- Automatic echo suppression
- Fully duplex communication
- Automatic setting of speaker volume
- Automatic setting of microphone sensitivity
- Interference suppression
- Automatic picking up of call

Video

- Integrated camera (only versions with camera)
- Integrated HD camera (2N® Helios IP Verso only)
- RTSP streaming server
- Up to 4 independent streams
- Web access to camera
- VGA video definition
- Connection of external IP camera
- Control of external IP camera
- Video before pick up

Software

- Integrated web server
- Software for bulk configuration
- Software for displaying video
- Software for video monitoring
- Application for Apple iPhone/iPad
- Application for Android 2.3 and higher

Interface

- Up to 4× relays
- Active output 8–14VDC/350–700mA
- Wiegand (only with RFID reader, or Wiegand module for 2N® Helios IP Verso)
- HTTP API for control
- Ethernet 100Mbit, PoE

Services

- Backup and automatic recording of configuration
- Automatic firmware update
- Network trace directly in equipment
- User sound customisation
- Systems log
- Event logging
- Time profiles

Integration

- Control of intercom over internet
- Control of locks
- Control of video
- Connection with CCTV
- Connection with access control

ANALOGUE ENVIRONMENT

2N® Helios**Security**

- Tamper switch (2N® Helios Uni, 2N® Helios Vario)
- Night vision (2N® Helios Vario)
- Possibility of RFID card reader (2N® Helios Vario)
- Access control

Physical security

- Cover level up to IP65 (2N® Helios Force, 2N® Helios Safety)
- Antivandal version (2N® Helios Force, 2N® Helios Safety)
- Security screws (2N® Helios Force, 2N® Helios Safety)
- Tamper switch (2N® Helios Force, 2N® Helios Uni, 2N® Helios Safety)

Communication

- Calling via exchange
- Up to 54 recordings
- Up to 6 numbers under one button Function “telephone” (models with keypads)
- Automatic picking up of call

Video

- Analogue camera as equipment (only 2N® Helios Vario)
- Camera definition 420 TV lines, PAL
- Night vision
- Integration via composite entry
- Possibility of connecting video server

Software

- No SW required

Interface

- Always one relay integrated
- Possibility of additional switch (apart from 2N® Helios Uni)
- RJ12 connector for simple connection (apart from 2N® Helios Vario, terminal strips)

Services

- Possibility of day/night mode
- Voice menu for configuration

Integration

- Only one free FXS port required at the exchange

IP ENVIRONMENT

2N® Helios IP Verso



Order No. **9155101**

Name 2N® Helios IP Verso
basic unit

Desc. basic unit



Order No. **9155101C**

Name 2N® Helios IP Verso
basic unit with camera

Desc.

- basic unit
- HD camera



Order No. **9155011**

Name 2N® Helios IP Verso
frame for installation in the wall

Desc.

- frame for installation in the wall
- 1 modul



Order No. **9155012**

Name 2N® Helios IP Verso
frame for installation in the wall

Desc.

- frame for installation in the wall
- 2 moduls



Order No. **9155013**

Name 2N® Helios IP Verso
frame for installation in the wall

Desc.

- frame for installation in the wall
- 3 moduls



Order No. **9155014**

Name 2N® Helios IP Verso
box for installation in the wall

Desc.

- box for installation in the wall
- 1 modul



Order No. **9155015**

Name 2N® Helios IP Verso
box for installation in the wall

Desc.

- box for installation in the wall
- 2 moduls



Order No. **9155016**

Name 2N® Helios IP Verso
box for installation in the wall

Desc.

- box for installation in the wall
- 3 moduls



Order No. **9155021**

Name 2N® Helios IP Verso
frame for installation
on the surface

Desc. · frame for installation
on the surface
· 1 modul



Order No. **9155022**

Name 2N® Helios IP Verso
frame for installation
on the surface

Desc. · frame for installation
on the surface
· 2 moduls



Order No. **9155023**

Name 2N® Helios IP Verso
frame for installation
on the surface

Desc. · frame for installation
on the surface
· 3 moduls



Order No. **9155030**

Name 2N® Helios IP Verso
infopanel

Desc. infopanel



Order No. **9155031**

Name 2N® Helios IP Verso
keypad

Desc. keypad



Order No. **9155032**

Name 2N® Helios IP Verso
RFID card reader

Desc. RFID card reader 125 kHz



Order No. **9155033**

Name 2N® Helios IP Verso
Čtečka RFID karet

Desc. RFID card reader 13 MHz



Order No. **9155034**

Name 2N® Helios IP Verso
I/O modul

Desc. I/O modul

2N® Helios IP Verso



Order No. **9155035**

Name 2N® Helios IP Verso
buttons

Desc. buttons



Order No. **9155037**

Name 2N® Helios IP Verso
wiegand modul

Desc. wiegand modul



Order No. **9155038**

Name 2N® Helios IP Verso
tamper switch

Desc. tamper switch



Order No. **9155039**

Name 2N® Helios IP Verso
blind module

Desc. blind module



Order No. **9155050**

Name 2N® Helios IP Verso
connection cable – long

Desc. connection cable – long

IP ENVIRONMENT

2N® Helios IP Vario



Order No. 9137111U

Name 2N® Helios IP Vario
1 button

Desc.

- 1 button
- control of one electric lock
- possibility of connecting card reader, extenders or information panel or additional switch



Order No. 9137131U

Name 2N® Helios IP Vario
3 buttons

Desc.

- 3 buttons
- control of one electric lock
- possibility of connecting card reader, extenders or information panel or additional switch



Order No. 9137161U

Name 2N® Helios IP Vario
3×2 buttons

Desc.

- 6 buttons
- control of one electric lock
- possibility of connecting card reader, extenders or information panel or additional switch



Order No. 9137111KU

Name 2N® Helios IP Vario
1 button + keypad

Desc.

- 1 button
- keypad
- control of one electric lock
- possibility of connecting card reader, extenders or information panel or additional switch



Order No. 9137131KU

Name 2N® Helios IP Vario
3 buttons + keypad

Desc.

- 3 buttons
- keypad
- control of one electric lock
- possibility of connecting card reader, extenders or information panel or additional switch



Order No. 9137161KU

Name 2N® Helios IP Vario
3×2 buttons + keypad

Desc.

- 6 buttons
- keypad
- control of one electric lock
- possibility of connecting card reader, extenders or information panel or additional switch



Order No. 9137111CU

Name 2N® Helios IP Vario
1 button + camera

Desc.

- 1 button
- camera
- control of one electric lock
- possibility of connecting card reader, extenders or information panel or additional switch



Order No. 9137131CU

Name 2N® Helios IP Vario
3 buttons + camera

Desc.

- 3 buttons
- camera
- control of one electric lock
- possibility of connecting card reader, extenders or information panel or additional switch

**Order No. 9137161CU**

Name 2N® Helios IP Vario
3 × 2 buttons + camera

Desc.

- 6 buttons
- camera
- control of one electric lock
- possibility of connecting card reader, extenders or information panel or additional switch

**Order No. 9137111CKU**

Name 2N® Helios IP Vario
1 button + keypad + camera

Desc.

- 1 Button
- camera
- keypad
- control of one electric lock
- possibility of connecting card reader, extenders or information panel or additional switch

**Order No. 9137131CKU**

Name 2N® Helios IP Vario
3 buttons + keypad + camera

Desc.

- 3 buttons
- camera
- keypad
- control of one electric lock
- possibility of connecting card reader, extenders or information panel or additional switch

**Order No. 9137161CKU**

Name 2N® Helios IP Vario
3 × 2 buttons + keypad + camera

Desc.

- 6 buttons
- camera
- keypad
- control of one electric lock
- possibility of connecting card reader, extenders or information panel or additional switch

**Order No. 9137160KDU**

Name 2N® Helios IP Vario
3 × 2 buttons + keypad + display

Desc.

- 6 buttons
- graphic display
- keypad
- control of one electric lock
- possibility of connecting card reader, extenders or information panel or additional switch

**Order No. 9137160CKDU**

Name 2N® Helios IP Vario – 3 × 2 buttons
+ keypad + camera + display

Desc.

- 6 buttons
- graphic display
- camera
- keypad
- control of one electric lock
- possibility of connecting card reader, extenders or information panel or additional switch

Expansion modules (2N® Helios IP Vario)



Order No. **9135181E**

Name 2N® Helios extendr
8 × 1 button

Desc. expansion module with 8 buttons

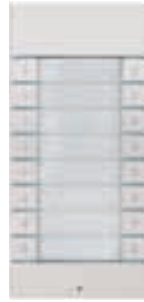

Order No. **9135182E**

Name 2N® Helios extendr
8 × 2 buttons

Desc. expansion module with 16 buttons



Order No. **9135310E**

Name 2N® Helios infopanel
no buttons

Desc. backlit panel without buttons,
used for inserting telephone list,
company logo, house numbers etc

Diagram for connection of expansion modules

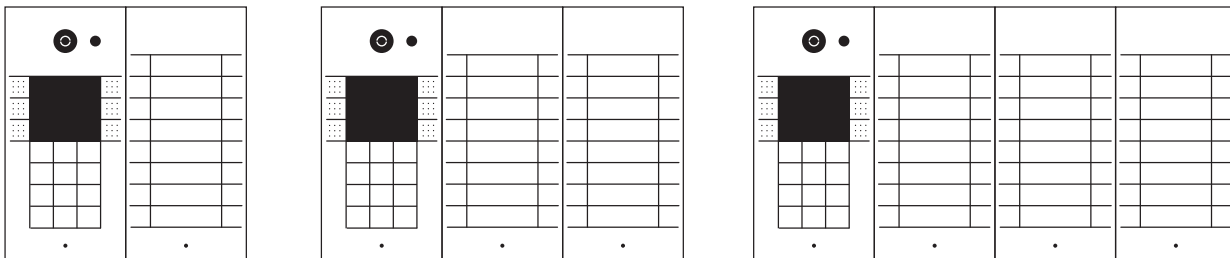

Possibility of connecting up to 54 buttons

Mounting elements (2N® Helios IP Vario)



Order No. 9135331E

Name 2N® Helios shelter for 1 module

Desc.

- shelter for external use
- installation on surface
- for one module



Order No. 9135332E

Name 2N® Helios shelter for 2 modules

Desc.

- shelter for external use
- installation on surface
- for two modules



Order No. 9135351E

Name 2N® Helios flush box for 1 module

Desc.

- box for installation in interior wall
- for one module



Order No. 9135352E

Name 2N® Helios flush box for 2 modules

Desc.

- box for installation in interior wall
- for two modules



Order No. 9135361E

Name 2N® Helios shelter and flush box for 1 module

Desc.

- shelter for use in external environment
- installation in wall
- for one module



Order No. 9135362E

Name 2N® Helios shelter and flush box for 2 modules

Desc.

- shelter for use in external environment
- installation in wall
- for two modules

IP ENVIRONMENT

2N[®] Helios IP Force

**Order No. 9151101**

Name 2N[®] Helios IP Force
1 button

Desc.

- 1 button
- control of two electric locks
- possibility of connecting additional switch

**Order No. 9151101C**

Name 2N[®] Helios IP Force
1 button + camera

Desc.

- 1 button
- camera
- control of two electric locks
- possibility of connecting additional switch

**Order No. 9151101W**

Name 2N[®] Helios IP Force
1 button + 10 W loudspeaker

Desc.

- 1 button
- 10 W loudspeaker
- extra robust version
- control of two electric locks
- possibility of connecting additional switch

**Order No. 9151101CW**

Name 2N[®] Helios IP Force – 1 button
+ camera + 10 W loudspeaker

Desc.

- 1 button
- camera
- 10 W loudspeaker
- extra robust version
- control of two electric locks
- possibility of connecting additional switch

**Order No. 9151104**

Name 2N[®] Helios IP Force
4 buttons

Desc.

- 4 buttons
- control of two electric locks
- possibility of connecting additional switch

**Order No. 9151104C**

Name 2N[®] Helios IP Force
4 buttons + camera

Desc.

- 4 buttons
- camera
- control of two electric locks
- possibility of connecting additional switch

**Order No. 9151101K**

Name 2N[®] Helios IP Force
1 button + keypad

Desc.

- 1 button
- keypad
- control of two electric locks
- possibility of connecting additional switch

**Order No. 9151101CK**

Name 2N[®] Helios IP Force
1 button + camera + keypad

Desc.

- 1 button
- keypad
- camera
- control of two electric locks
- possibility of connecting additional switch



Order No. **9151102R**

Name 2N® Helios IP Force
2 buttons
(card reader ready)

Desc.

- 2 buttons
- possibility of connecting card reader
- control of two electric locks
- possibility of connecting additional switch



Order No. **9151102CR**

Name 2N® Helios IP Force
2 buttons + camera
(card reader ready)

Desc.

- 2 buttons
- camera
- possibility of connecting card reader
- control of two electric locks
- possibility of connecting additional switch



Order No. **9151101CRP**

Name 2N® Helios IP Force
1 button with pictograms

Desc.

- 1 button
- camera
- 10W loudspeaker
- extra robust version
- control of two electric locks
- possibility of connecting additional switch

Mounting elements (2N® Helios IP Force)



Order No. **9151001E**

Name flush wall box

Desc. box for installation in wall



Order No. **9151002**

Name flush plasterboard box

Desc. box for installation in plasterboard

IP ENVIRONMENT

2N[®] Helios IP Safety



Order No. **9152101**

Name 2N[®] Helios IP Safety
1 button

Desc.

- 1 button
- control of two electric locks
- possibility of connecting additional switch



Order No. **9152101W**

Name 2N[®] Helios IP Safety
1 button + 10W loudspeaker

Desc.

- 1 button
- 10 W loudspeaker
- extra robust version
- control of two electric locks
- possibility of connecting additional switch

Mounting elements (2N[®] Helios IP Safety)



Order No. **9151001E**

Name flush wall box

Desc. box for installation in wall



Order No. **9151002**

Name flush plasterboard box

Desc. box for installation in plasterboard

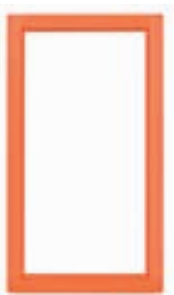

Order No. **9152000**

Name 2N[®] Helios IP Safety
frame (orange)

Desc. orange frame suitable for covering edges when installed in wall

IP ENVIRONMENT

2N[®] Helios IP Uni

Order No. **9153101**

Name 2N[®] Helios IP Uni
1 button

Desc.

- 1 button
- control of one electric lock
- protective switch

Order No. **9153102**

Name 2N[®] Helios IP Uni
2 buttons

Desc.

- 2 buttons
- control of one electric lock
- protective switch

Obj. kód **9153101P**

Název 2N[®] Helios IP Uni
1 button with pictograms

Popis

- 1 button
- control of one electric lock
- protective switch

Mounting elements (2N[®] Helios IP Uni)

Order No. **9153003**

Name 2N[®] Helios IP Uni
wall box

Desc. box for surface installations

2N[®] Indoor Touch

Order No. **91378365**

Name 2N[®] Indoor Touch

Desc. Indoor touch unit for audio and video communication with IP intercom

IP ENVIRONMENT

Equipment



Order No. **9135301E**

Name Replacement nameplate one button (2N® Helios IP Vario)

Desc. Replacement nameplate one button



Order No. **9135302E**

Name Replacement nameplate two buttons (2N® Helios IP Vario)

Desc. Replacement nameplate two buttons



Order No. **9135311E**

Name Nameplate for information panel (2N® Helios IP Vario)

Desc.

- replacement of four nameplates with one cover
- allows use of half of the expansion module, for telephone list, office hours etc.



Order No. **91341481E**

Name 12V power adapter

Desc.

- stabilised 12V/2A power source
- must be used if PoE power is not used



Order No. **932070E**

Name Standard electric lock

Desc. standard electric lock BEFO 1211 12V/600mA



Order No. **932080E**

Name Electric lock with torque bolt

Desc.

- electric lock with torque bolt BEFO 221 12V/600mA
- a brief (momentary) electrical impulse which releases the lock and puts it in the OPEN position is all that is required to open (release) the lock
- a brief electrical after entering the lock is CLOSED



Order No. **932090E**

Name Electric lock with mechanical blocking

Desc.

- Electric lock with mechanical blocking BEFO 1211MB 12V/600mA
- allows the mechanical setting of the lever in the OPEN or CLOSED position
- in the OPEN position it is permanently open, otherwise it behaves like a standard lock



Order No. **932928**

Name 12V AC transformer for electric lock

Desc. for supply of external 12V alternating power

**Order No. 91378100E**

Name PoE injector
EU socket

Desc. for powering an intercom over an Ethernet cable in the absence of a PoE switch

**Order No. 9137310E**

Name Additional switch
(only for 2N® Helios IP Vario)

Desc.

- allows the control of a second appliance
- make and break contact optional
- switching for unlimited period max. 48V/2A

**Order No. 9159010**

Name 2N® Helios IP
Security relay

Desc.

- simple additional equipment to increase security
- prevents tampering with the lock
- It is installed between the intercom, from which it is also powered, and the lock which it controls

**Order No. 9137410E**

Name 2N® Helios IP
Security relay – 1 output

Desc.

- separate IP equipment which may be controlled from the IP intercom thanks to HTTP commands
- allows the control of one device at any distance

**Order No. 9137411E**

Name 2N® Helios IP
security relay – 4 outputs, PoE

Desc.

- separate IP equipment which may be controlled from the IP intercom thanks to HTTP commands
- allows the control of up to four devices at any distance

**Order No. 9151010**

Name Additional switch + protective switch
(only for 2N® Helios IP Force)

Desc.

- allows the control of a second appliance
- passive switching for unlimited period
- max. 30V/1A or active 12V DC / max 700 mA
- also contains protective switch to signal/report/warn/notify if front panel is opened



**Order No. 9137420E**

Name External RFID card reader (USB)

- Desc.**
- External RFID card reader
 - for connection to PC via USB interface
 - suitable for management of system and addition of cards via PC application 2N® Helios IP Manager
 - reads EM4100, EM4102 cards

**Order No. 9137430E**

Name 2N® Helios IP card reader (only for 2N® Helios IP Vario)

- Desc.**
- internal RFID card reader
 - for fitting in 2N® Helios IP Vario basic module
 - reads cards EM4100, EM4102 and HID Proximity, 125kHz
 - another two switches and Wiegand interface
 - compatible with all 2N® Helios IP Vario models

**Order No. 9151011**

Name 2N® Helios IP card reader + protective switch (only for 2N® Helios IP Force)

- Desc.**
- internal RFID card reader
 - for fitting in 2N® Helios IP Force
 - reads cards EM4100, EM4102 and HID Proximity, 125kHz
 - another two switches and Wiegand interface
 - compatible with 9151102xR 2N® Helios IP Force 2 buttons and readiness for reader

**Order No. 9159030**

Name External RFID card reader

- Desc.**
- secondary reader for connection to internal reader
 - allows control of entry by card from both sides of door
 - cover IP67
 - also suitable for exterior
 - reads EM4100, EM4102 cards

**Order No. 9134165E**

Name Chip card

- Desc.**
- contactless card for access system
 - Type EM4100

**Order No. 9134166E**

Name Chip key ring

- Desc.**
- contactless key ring for access system
 - Type EM4100

**Obj. kód 9151016**

Název 2N® Helios IP RFID card reader 13 MHz

- Popis**
- internal RFID card reader for fitting in 2N® Helios IP Force
 - reads cards Mifare, iClass, DESFire and other standards
 - another two switches, logical inputs and Wiegand module
 - compatible with 2N® Helios IP Force 2 buttons and pictograms.
 - contains protective switch

2N® Helios IP Licence

Licences and licence functions are not available for 2N® Helios IP Uni.

2N® Helios IP Vario with display already has a Gold licence loaded.



Order No. 9137905

Name 2N® Helios IP
Enhanced Audio licence

Desc. Licence for unlocking advanced audio functions.



Order No. 9137906

Name 2N® Helios IP
Enhanced Video licence

Desc. Licence for unlocking advanced video functions.



Order No. 9137907

Name 2N® Helios IP
Enhanced Integration licence

Desc. Licence for unlocking advanced integration functions



Order No. 9137908

Name 2N® Helios IP
Enhanced Security licence

Desc. Licence for unlocking advanced security functions.



Order No. 9137909

Name 2N® Helios IP
Gold licence

Desc. Licence for unlocking all advanced functions.



Order No. 9137902

Name 2N® Helios IP
Licence G729 (pro 2N® Helios IP +
2N® SIP Speaker)

Desc. Licence for unlocking audio codex G.729.

2N® Helios IP Manager

2N® Helios IP Manager for 1 device unlimited period of time,

or for five devices for 30 days, is available for free download on www.2n.cz



Order No. 9137911

Name 2N® Helios IP Manager
licence for supervision
of 2–5 devices

Desc.

- software for collective management of intercoms
- configuration of display
- advanced management of access system users
- the number of intercoms in a single installation is restricted by license



Order No. 9137912

Name 2N® Helios IP Manager
licence for supervision
of 6–20 devices

Desc.

- software for collective management of intercoms
- configuration of display
- advanced management of access system users
- the number of intercoms in a single installation is restricted by license



Order No. 9137913

Name 2N® Helios IP Manager
licence for supervision
of 21–50 devices

Desc.

- software for collective management of intercoms
- configuration of display
- advanced management of access system users
- the number of intercoms in a single installation is restricted by license



Order No. 9137914

Name 2N® Helios IP Manager
unlimited licence for supervision
of devices

Desc.

- software for collective management of intercoms
- configuration of display
- advanced management of access system users
- the number of intercoms in a single installation is restricted by license

IP ENVIRONMENT

2N® NetSpeaker

**Order No. 914010E**

Name 2N® NetSpeaker

Desc.

- IP audio decoder
- 14 W amplifier
- PoE/12 V
- 10/100Base Ethernet
- terminals for connecting loudspeakers 4–16 Ohm

**Order No. 914031E**

Name 2N® NetSpeaker
Ceiling Loudspeaker – IC Audio

Desc.

- IP audio decoder built into flush ceiling-mounted speaker
- 14 W
- PoE/12 V
- 10/100Base Ethernet

**Order No. 914202E**

Name 2N® NetSpeaker Server SW
free to download from 2N web site (including 5× NSP licences)

Desc.

- SW application for configuration and control of NetSpeaker system
- free licence for connection of 5× NetSpeaker

**Order No. 914204E**

Name 2N® NetSpeaker Server
1× NSP add on licence

Desc. 1× additional licence for connection of 1× NetSpeaker (necessary if 6 or more connected NetSpeakers)

**Order No. 914060E**

Name 2N® NetSpeaker PC (inc. Win 7, NetSpeaker Server SW 914202E, totally 10NSP licences)

Desc.

- PC with installation of Windows 7
- NetSpeaker Server SW application
- 10 licences for connection free of charge
- 10× NetSpeaker

IP ENVIRONMENT

2N[®] SIP Speaker



Order No. **914401E**

Name 2N[®] SIP Speaker
StandAlone box

Desc.

- IP audio decoder
- 18W amplifier
- PoE/12V
- 10/100Base Ethernet
- terminals for connecting loudspeakers 4–16 Ohm
- support for SIP protocol



Order No. **914420E**

Name 2N[®] SIP Speaker
Loudspeaker Set, wall mounted

Desc.

- IP audio decoder built into wall-mounted loudspeaker
- 18W amplifier
- PoE/12V
- 10/100Base Ethernet
- support for SIP protocol



Order No. **914430E**

Name 2N[®] SIP Speaker
Loudspeaker Set, flush mounted

Desc.

- IP audio decoder built into flush-mounted speaker
- 18W amplifier
- PoE/12V
- 10/100Base Ethernet
- support for SIP protocol



Order No. **914102E**

Name 2N[®] NetSpeaker/SIP Speaker
Power Supply

Desc. Stabilised 12V/2A, power source, must be used if PoE power is not used



Order No. **914105E**

Name 2N[®] NetSpeaker
Mounting set

Desc. fitting set for wall installation

2N[®] NetMic



Order No. **914071E**

Name 2N[®] NetMic Organic

Desc. Hardware console with microphone for live announcements or for broadcasting pre-recorded files to various zones

ANALOGUE ENVIRONMENT

2N[®] Helios Vario

**Order No. 9135110E**

Name 2N[®] Helios Vario
1 button

Desc.

- 1 button
- control of one electric lock
- possibility of connecting extenders or information panel or additional switch

**Order No. 9135130E**

Name 2N[®] Helios Vario
3 buttons

Desc.

- 3 buttons
- control of one electric lock
- possibility of connecting extenders or information panel or additional switch

**Order No. 9135160E**

Name 2N[®] Helios Vario
3 × 2 buttons

Desc.

- 6 buttons
- control of one electric lock
- possibility of connecting extenders or information panel or additional switch

**Order No. 9135110KE**

Name 2N[®] Helios Vario
1 button + keypad

Desc.

- 1 button
- keypad
- control of one electric lock
- possibility of connecting extenders or information panel or additional switch

**Order No. 9135130KE**

Name 2N[®] Helios Vario
3 buttons + keypad

Desc.

- 3 buttons
- keypad
- control of one electric lock
- possibility of connecting extenders or information panel or additional switch

**Order No. 9135160KE**

Name 2N[®] Helios Vario
3 × 2 buttons + keypad

Desc.

- 6 buttons
- keypad
- control of one electric lock
- possibility of connecting extenders or information panel or additional switch

Expansion modules (2N® Helios Vario)



Order No. 9135181E

Name 2N® Helios extendr
8 × 1 button

Desc. • expansion module with 8 buttons

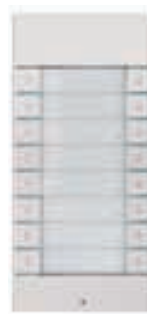

Order No. 9135182E

Name 2N® Helios extendr
8 × 2 buttons

Desc. • expansion module with 16 buttons



Order No. 9135310E

Name 2N® Helios infopanel
no buttons

Desc. • backlit panel without buttons
• serves for telephone numbers, company logo, house numbers etc

Diagram for connection of expansion modules

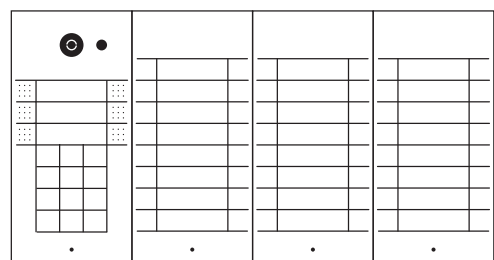
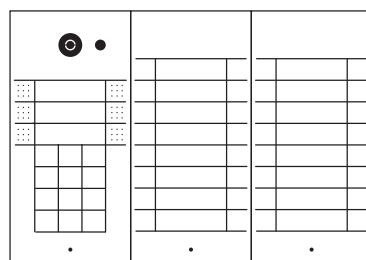
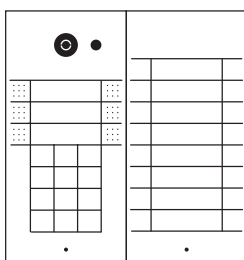

Possibility of connecting up to 54 buttons

Mounting elements (2N® Helios Vario)



Order No. 9135331E

Name 2N® Helios
shelter for 1 module

Desc.

- shelter for external use
- installation on surface
- for one module



Order No. 9135332E

Name 2N® Helios
shelter for 2 modules

Desc.

- shelter for external use
- installation on surface
- for two modules



Order No. 9135351E

Name 2N® Helios
flush box for 1 module

Desc.

- box for installation in internal wall
- for one module



Order No. 9135352E

Name 2N® Helios
flush box for 2 modules

Desc.

- box for installation in internal wall
- for two modules



Order No. 9135361E

Name 2N® Helios
shelter and flush box for 1 module

Desc.

- shelter for use in external environment
- installation in wall
- for one module



Order No. 9135362E

Name 2N® Helios
shelter and flush box for 2 modules

Desc.

- shelter for use in external environment
- installation in wall
- for two modules

ANALOGUE ENVIRONMENT

2N[®] Helios Force



Order No. **9151201-E**

Name 2N[®] Helios Force
1 button

Desc. • 1 button
• control of up to two electric locks
• integrated amplifier



Order No. **9151204-E**

Name 2N[®] Helios Force
4 buttons

Desc. • 4 buttons
• control of up to two electric locks
• integrated amplifier



Order No. **9151201K-E**

Name 2N[®] Helios Force
1 button + keypad

Desc. • 1 button
• keypad
• control of up to two electric locks
• integrated amplifier

Mounting elements (2N[®] Helios IP Force)



Order No. **9151001E**

Name flush wall box

Desc. box for installation in wall



Order No. **9151002**

Name flush plasterboard box

Desc. box for installation in plasterboard

ANALOGUE ENVIRONMENT

2N[®] Helios Safety



Order No. **9152201-E**

Name 2N[®] Helios Safety
1 button

Desc.

- 1 button
- control of up to two electric locks
- integrated amplifier

Mounting elements (2N[®] Helios Safety)



Order No. **9151001E**

Name flush wall box

Desc. box for installation in wall



Order No. **9151002**

Name flush plasterboard box

Desc. box for installation in plasterboard

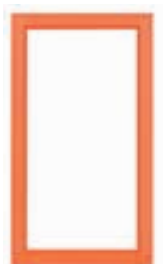

Order No. **9152000**

Name 2N[®] Helios Safety
frame (orange)

Desc. orange frame suitable for covering
edges when installed in wall

ANALOGUE ENVIRONMENT

2N[®] Helios Uni



Order No. **9153201-E**

Name 2N[®] Helios Uni
1 button

Desc. • 1 button
• control of one electric lock
• protective switch



Order No. **9153202-E**

Name 2N[®] Helios Uni
2 buttons

Desc. • 2 buttons
• control of one electric lock
• protective switch

Mounting elements (2N[®] Helios Uni)



Order No. **9153003**

Name 2N[®] Helios Uni
wall box

Desc. box for surface installations

ANALOGUE ENVIRONMENT

Equipment



Order No. 9135301E

Name Replacement nameplate
(2N® Helios Vario)

Desc. replacement nameplate
one button



Order No. 9135302E

Name Replacement nameplate
(2N® Helios Vario)

Desc. replacement nameplate
two buttons



Order No. 9135311E

Name Nameplate for information panel
(2N® Helios Vario)

Desc.

- replacement of four nameplates with one cover
- allows use of half of the expansion module, for example for insertion of telephone list, office hours etc.



Order No. 91341481E

Name 12V power adapter

Desc.

- stabilised 12V/ 2A source
- must be used if PoE power is not used



Order No. 932070E

Name Standard electric lock

Desc. standard electric lock
BEFO 1211 12V/ 600mA



Order No. 932080E

Name Electric lock with torque bolt

Desc.

- electric lock with torque bolt BEFO 221 12V/ 600mA
- a brief (momentary) electrical impulse which releases the lock and puts it in the OPEN position is all that is required to open (release) the lock
- after entering the door the lock is CLOSED in the resting position



Order No. 932090E

Name Electric lock
with mechanical blocking

Desc.

- Electric lock with mechanical blocking BEFO 1211MB 12V/ 600mA
- allows the mechanical setting of the lever in the OPEN or CLOSED position
- in the OPEN position it is constantly open, otherwise it behaves like a standard lock



Order No. 932928

Name 12V AC transformer
for electric lock

Desc. for supply of external 12V
alternating power

**Order No. 9137310E**

Name additional switch
(for 2N® Helios Vario)

Desc.

- allows the control of a second appliance
- possibility of make and break contact
- passive switching for unlimited period
- max. 48V/ 2A

**Order No. 9135200E**

Name built in colour CCD camera
(for 2N® Helios Vario)

Desc.

- the camera can be built into every basic unit, even after installation
- if there is insufficient light, the camera automatically switches to the black and white mode
- infrared illumination
- if mounted horizontally, the camera can also be rotated vertically

**Order No. 9134137E**

Name Video server
MPEG4 LAN

Desc.

- the video can be viewed via LAN on any PC
- no SW needed
- can serve up to 10 PC at the same time
- thanks to MPEG-4 compression the network load is roughly 10 times smaller than in the case of M-JPEG compression
- it also is possible to use the internet for online streaming
- possibility of setting quality/ data flow
- free SW for intelligent video recording on PC (movement detection)

The vision becomes reality ...

For the correct installation of intercoms you need to know the technical parameters, requirements for connection and installation dimensions.



Installation

IP intercoms

2N® Helios IP Verso

TECHNICAL PARAMETERS

Signalling protocol

SIP (UDP, TCP, TLS)

Buttons

Button design	White-backlit transparent buttons with replaceable nametag
Button count	1 and increments of 146
Button extenders	Up to 30 modules, limited by power supply
Numeric keypad	optional

Audio

Microphone	1 integrated microphone
Amplifier	2 W (class D) amplifier
Speaker	2W/8Ω
Output LINE OUT	1 VRMS/600Ω
Volume control	Adjustable with automatic adaptive mode
Full duplex	Yes (AEC)

Audio stream

Protocols	RTP/RTSP
Codecs	G.711, G.729

Camera

Sensor	1/3" colour CMOS
JPEG resolution	Up to 1280 (H) × 960 (V)
Video resolution	640 (H) × 480 (V)
Frame rate	Up to 30 snapshots/s
Sensitivity	5.6V/lux-sec (550nm)
View angle	120° (H), 90° (V), 145° (D)
Infrared light	Yes

Video stream

Protocols	RTP/RTSP/http
Codecs	H.263, H.263+, H.264, MPEG-4, M-JPEG
IP camera function	Yes, ONVIF v2.2 profile S compatible

Interface

Power supply	12V ± 15% / 2A DC or PoE
PoE	PoE 802.3af (Class 0–12.95W)
LAN	10/100BASE-TX s Auto-MDIX, RJ-45
Recommended cabling	Cat-5e or higher
Supported protocols	SIP2.0, DHCP opt. 66, SMTP, 802.1x, RTSP, RTP, TFTP, HTTP, HTTPS, Syslog
Passive switch	NO/NC contact, up to 30V/1A AC/DC
Active switch output	8 up to 12V DC depending on power supply (PoE: 10V; adaptor: power supply voltage minus 2V), max 400mA



RFID card reader

	Optionally 125 kHz or 13.56 MHz
Supported cards	125 kHz – EM4100, EM4102, HID Prox 13.56 MHz
ISO14443A	Mifare Classic 1k & 4k, DESFire EV1, Mini, Plus S&X, SmartMX, Ultralight
ISO14443B	Ultralight C, SLE44R35, my-d move (SLE66Rxx), PayPass, Legic Advant Calypso, CEPAS, Moneo, SRI512, SRT512, SRI4K, SRIX4K, PicoPass, HID iCLASS

Mechanical properties

Cover	Robust zinc casting with surface finish
Working temperature	-40 °C – 60 °C
Working relative humidity	10% – 95% (non-condensing)
Storing temperature	-40 °C – 70 °C
Dimensions	
	1 modul: 107 (W) × 130 (H) × 28 (D) mm
Surface mounting frame	2 moduls: 107 (W) × 234 (H) × 28 (D) mm 3 moduls: 107 (W) × 339 (H) × 28 (D) mm
Flush mounting frame	1 modul: 130 (W) × 153 (H) × 5 (D) mm 2 moduls: 130 (W) × 257 (H) × 5 (D) mm 3 moduls: 130 (W) × 361 (H) × 5 (D) mm
Flush mounting box (minimum hole dimensions)	1 modul: 108 (W) × 131 (H) × 45 (D) mm 2 moduls: 108 (W) × 238 (H) × 45 (D) mm 3 moduls: 108 (W) × 343 (H) × 45 (D) mm
Weight	Based on configuration
Covering level	IP54

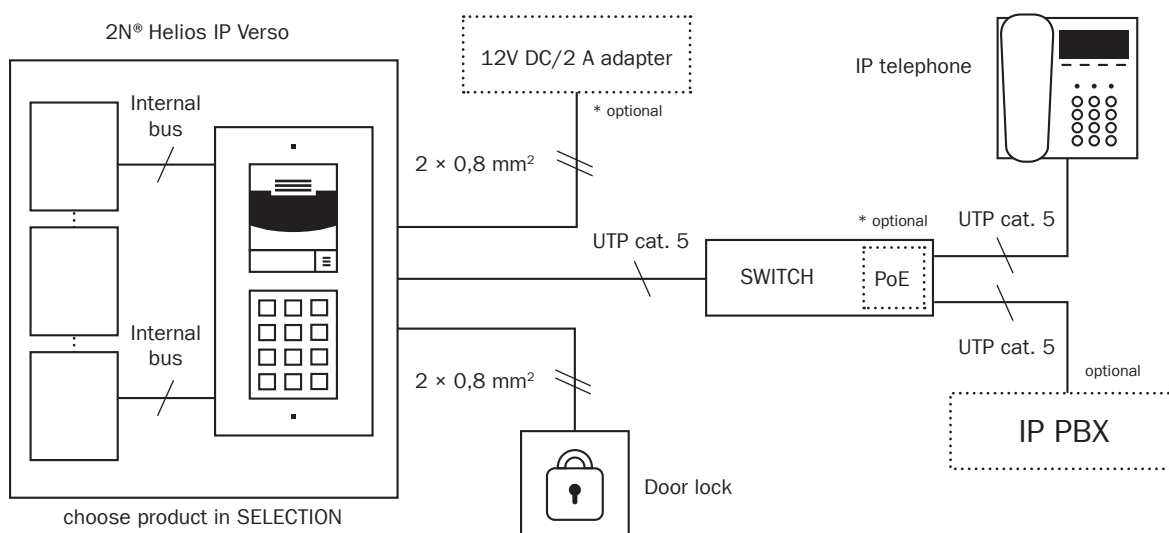
CONNECTION DIAGRAM

2N® Helios IP Vario

TECHNICAL PARAMETERS



Signalling protocol

	SIP (UDP)
--	-----------

Buttons

	Buttons
--	---------

Button finish	Stainless steel buttons
Number of buttons	1, 3 or 6
Button expansion	up to 54 using expansion modules
Numerical keypad	optional

Audio

	Audio
--	-------

Volume control	adjustable
Full duplex	yes (AEC)

Audio stream

	Audio stream
--	--------------

Protocols	RTP/RTSP
Codecs	G.711, G.729

Camera

	Camera
--	--------

Sensor	1/4" colour CMOS
Definition	640 (H) × 480 (V)
Frame rate	up to 30 frames/s
Sensitivity	1,9V/lux-sec (550 nm)
Viewing angle	55° (H), 39° (V)

Video stream

Protocols	RTP/RTSP/http
Codecs	H.263+, H.264, MPEG-4, M-JPEG
IP camera functions	Yes

Interface

Power supply	12V ± 15% / 2A DC or PoE
PoE	PoE 802.3af (Class 0 – 12,95 W)
LAN	10/100BASE-TX with Auto-MDIX
Recommended cabling	Cat-5e or better
Passive switch	make and break contact, max. 30V / 1A AC/DC
Active output of switch	10 up to 14V DC depending on power supply, max. 700mA

RFID card reader

	optional
Supported cards	EM-40XX (125 KHz) HID Proximity (125 kHz, 26 bit)

Mechanical properties

Operating temperature	-20 °C – 55 °C
Operating relative humidity	10% – 95% (non-condensing)
Storage temperature	-40 °C – 70 °C
Dimensions	210 × 100 × 29 mm
Weight	500 g
Cover rating	IP44, IP53 if shelter is used (see equipment for installation)

CONNECTION DIAGRAM

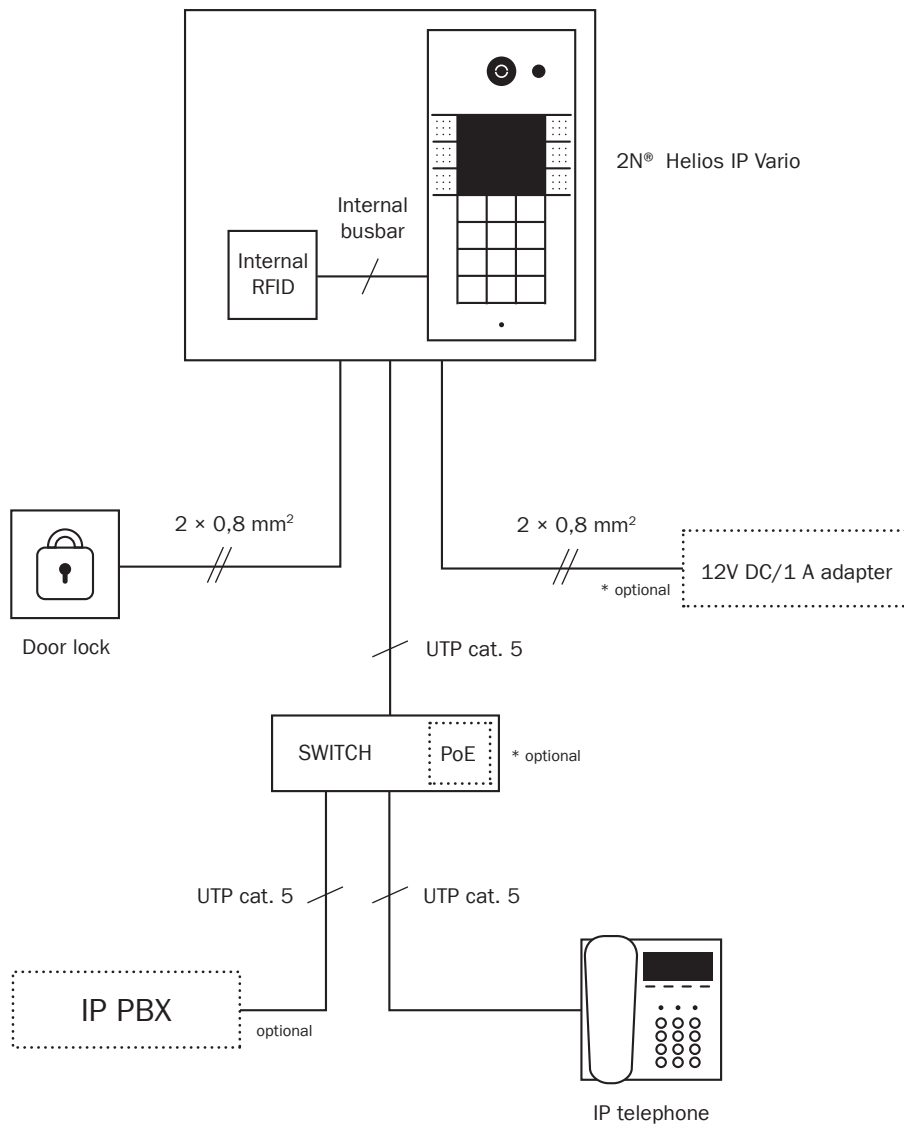

* Power from external 12V adapter or POE

2N® Helios IP Force

TECHNICAL PARAMETERS



Signalling protocol

SIP (UDP)

Buttons

Button finish	Transparent buttons with white backlighting and nameplate which can be replaced with ease
Number of buttons	1, 2 or 4
Numerical keypad	optional

Audio

Microphone	2 integrated microphones
Amplifier	10W (class D) amplifier
Speaker	1W (10W optional)
Volume control	adjustable with automatic adaptive mode
Full duplex	yes (AEC)

Audio stream

Protocols	RTP/RTSP
Codecs	G.711, G.729

Camera

Sensor	1/4" colour CMOS
Definition	640 (H) × 480 (V)
Frame rate	up to 30 frames/s
Sensitivity	1,9V/lux-sec (550 nm)
Viewing angle	135° (H), 109° (V)
Infrared illumination	Yes

Video stream

Protocols	RTP/RTSP/http
Codecs	H.263+, H.264, MPEG-4, M-JPEG
IP camera functions	Yes

Interface

Power supply	12V ± 15%/2A DC or PoE
POE	PoE 802.3af (Class 0 – 12,95W)
LAN	10/100BASE-TX with Auto-MDIX, RJ-45
Recommended cabling	Cat-5e or better
Passive switch	make and break contact, max. 30V/1A AC/DC
Active output of switch	10 up to 14V DC depending on power supply, max. 700mA

RFID card reader

	optional
Supported cards	EM-40XX (125 KHz)
	HID Proximity (125 kHz, 26 bit)
	iClass DESFire and Mifare (13.56MHz)

Mechanical properties

Cover	Robust aluminium casting
Operating temperature	-40 °C–55 °C
Operating relative humidity	10%–95% (non-condensing)
Storage temperature	-40 °C–70 °C
Dimensions	217 × 109 × 83 mm
	242 × 136 × 83 mm with frame
Weight	net max. 2 kg / gross max. 2,5 kg
Cover rating	IP65, IP69K (91511xxxW)

CONNECTION DIAGRAM

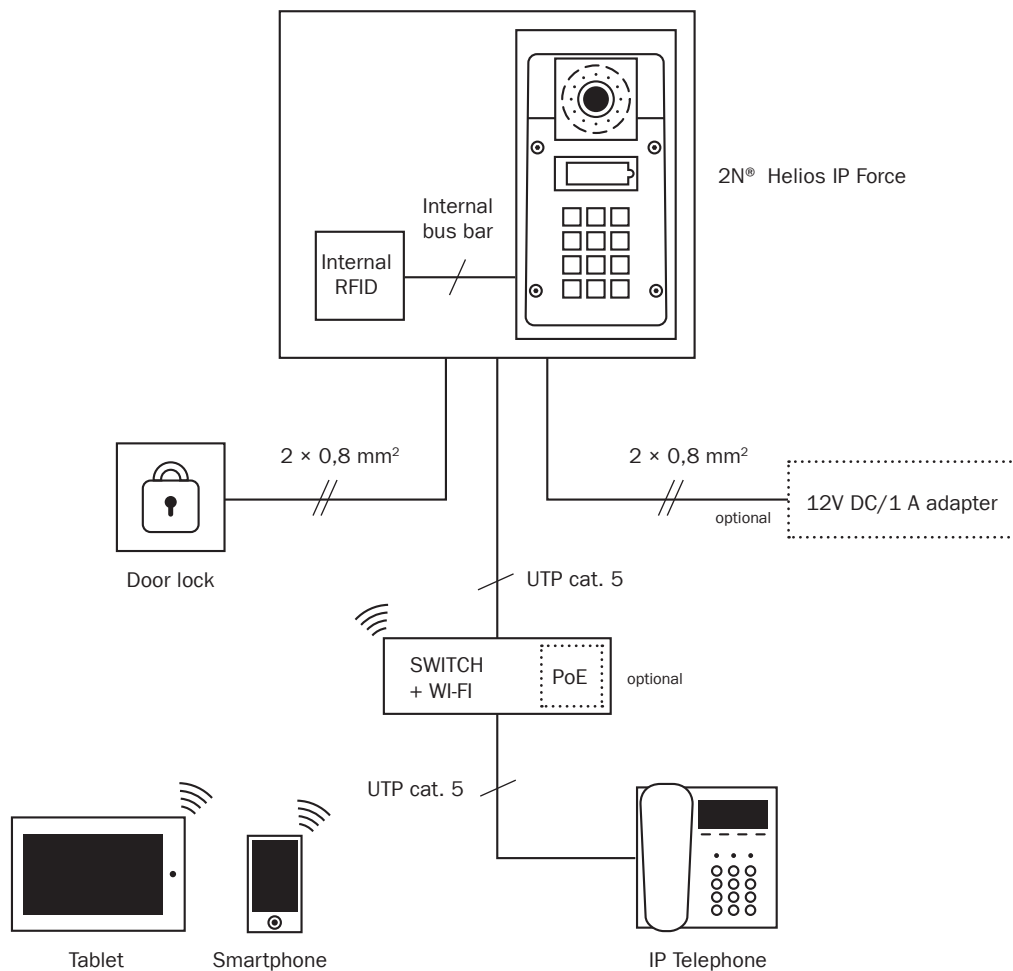

* Power from external 12V adapter or POE

2N® Helios IP Safety

TECHNICAL PARAMETERS

Signalling protocol

SIP (UDP)

Buttons

Button finish	Industrial waterproof buttons, vandal-proof, stainless steel, blue backlit
Number of buttons	1

Audio

Microphone	2 integrated microphones
Amplifier	10W (class D) amplifier
Speaker	1W (10W optional)
Volume control	adjustable with automatic adaptive mode
Full duplex	yes (AEC)

Audio stream

Protocols	RTP/RTSP
Codecs	G.711, G.729

Interface

Power supply	12V ± 15%/2A DC or PoE
POE	PoE 802.3af (Class 0–12,95W)
LAN	10/100BASE-TX with Auto-MDIX, RJ-45
Recommended cabling	Cat-5e or better
Passive switch	make and break contact, max. 30V/1A AC/DC
Active output of switch	9–13V DC/700 mA

Mechanical properties

Cover	Robust aluminium casting
Colour	RAL 2004 (orange)
Operating temperature	-40 °C–55 °C
Operating relative humidity	10%–95% (non-condensing)
Storage temperature	-40 °C–70 °C
Dimensions	217 × 109 × 83 mm
Weight	net max. 2 kg / gross max. 2,5 kg
Cover rating	IP65, IP69K (91511xxxW)



CONNECTION DIAGRAM

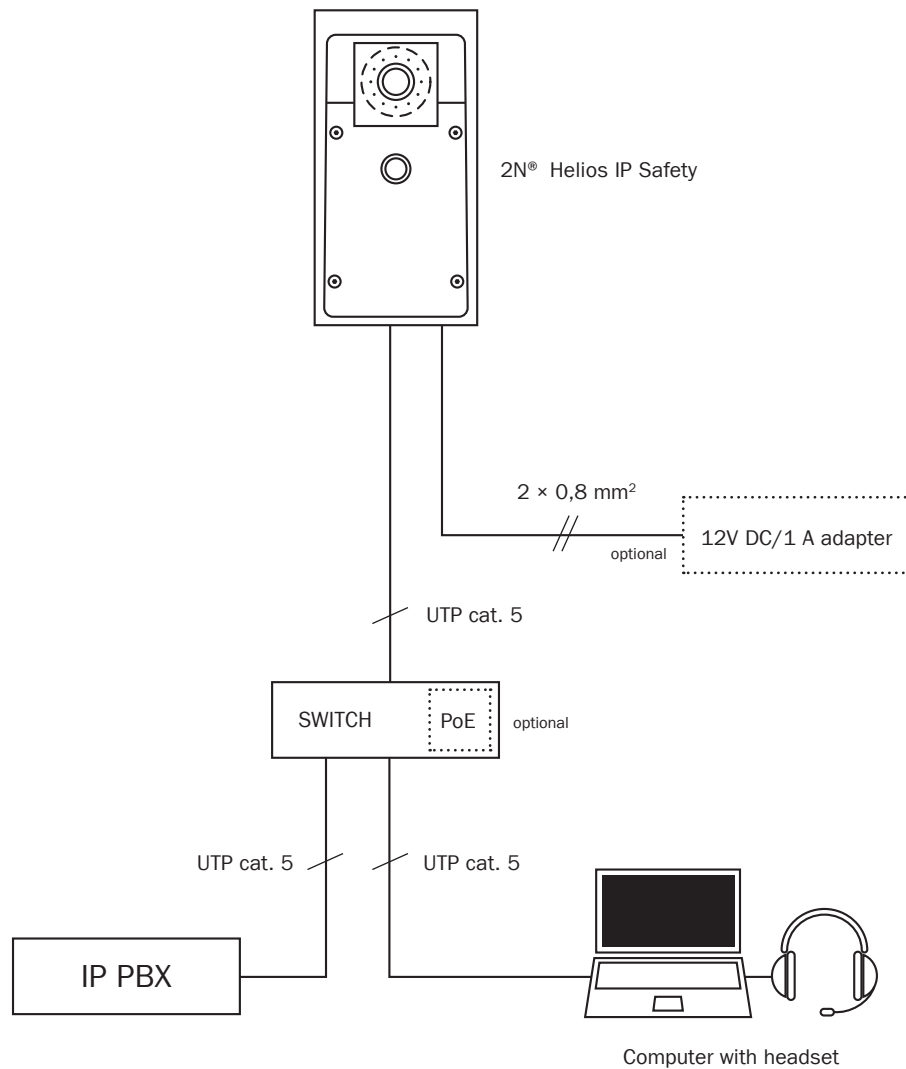

* Power from external 12V adapter or POE

2N® Helios IP Uni

TECHNICAL PARAMETERS

Signalling protocol

SIP (UDP)

Buttons

Button finish	Transparent buttons with white backlighting and nameplate which can be replaced with ease
Number of buttons	1 or 2

Audio

Microphone	1 integrated microphone
Amplifier	1 W (class D) amplifier
Speaker	1 W
Volume control	adjustable with automatic adaptive mode
Full duplex	yes (AEC)

Audio stream

Protocols	RTP/RTSP
Codecs	G.711

Interface

Power supply	12V ± 15%/2A DC or PoE
POE	PoE 802.3af (Class 0–12,95 W)
LAN	10/100BASE-TX with Auto-MDIX, RJ-45
Recommended cabling	Cat-5e or better
Passive switch	make and break contact, max. 30V/1A AC/DC
Active output of switch	8–12V DC/500 mA

Mechanical properties

Cover	ABS plastic, high-quality stainless steel
Operating temperature	-40 °C – 55 °C
Operating relative humidity	10% – 95% (non-condensing)
Storage temperature	-40 °C – 70 °C
Dimensions	193 × 115 × 39 mm
	197 × 119 × 47 mm flush fitting box
	193 × 115 × 57 mm when fitted on surface
Weight	product net: 500 g
	wiring box: 135 g
	total including container: 800 g
Cover rating	IP54



CONNECTION DIAGRAM

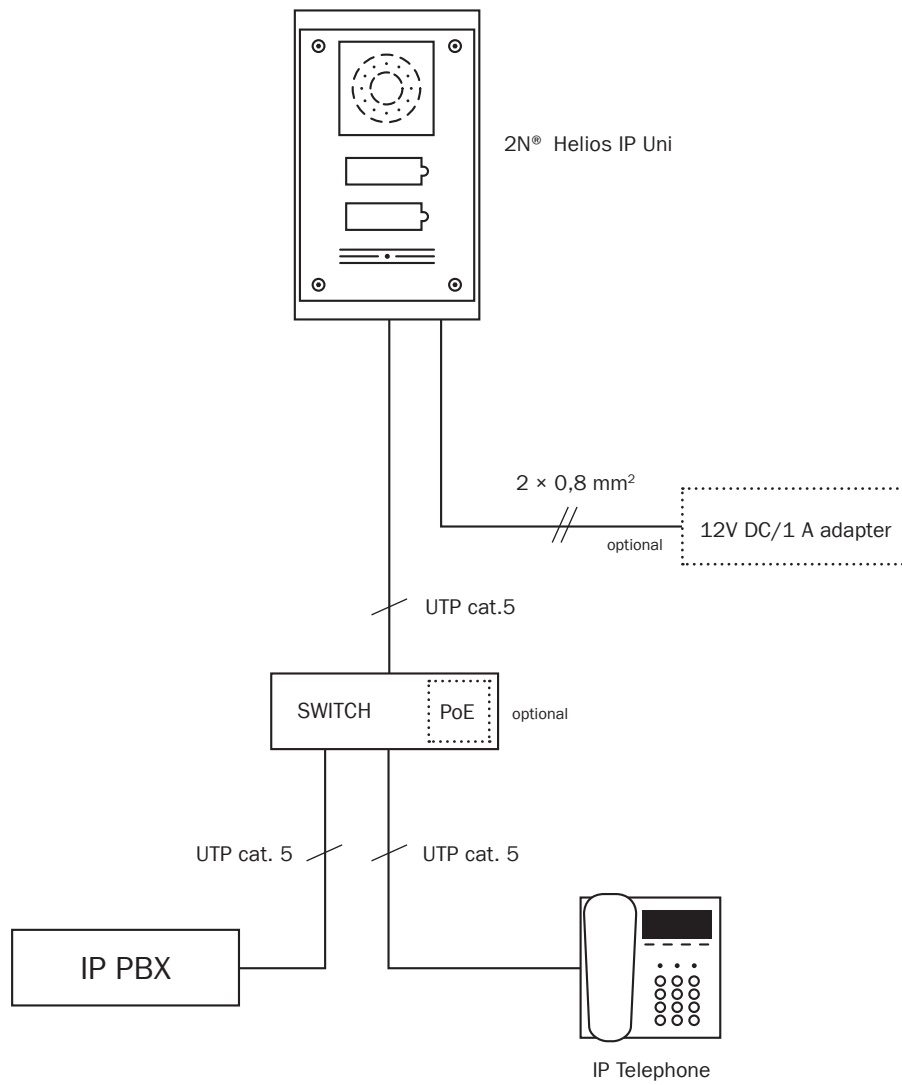

2N® Indoor Touch

TECHNICAL PARAMETERS

Signaling protocol

	SIP
--	-----

User interface

Display	High-capacity touchscreen 16:9, 7" display, resolution 1024 × 600 px 24 bpp (16.7 million colours), backlit LED with power saving mode, 1× RGB LED status indicator (missed calls, power saving mode, etc.)
---------	---

Audio

Microphone	Integrated microphone
Amplifier	Integrated 1× 2W speaker

Video

Protocols	RTSP, MJPEG/HTTP
Supervision and control of intercom	Yes
IP camera surveillance	Yes

Operating system

OS version	Android 4.2
------------	-------------

Interface

LAN	Ethernet 10/100BaseT, RJ-45
Recommended cabling	Cat-5e or better
Memory card	SD type (up to 16 GB)
Power supply	External power adapter 12V DC 2A / PoE 802.3af Power consumption 10W, GPIOs

Mechanical properties

General	On-wall installation
Operating temperature	0 °C – 60 °C
Operating relative humidity	10% – 90% (non-condensing)
Storage temperature	-20 °C – 70 °C
Dimensions	235 × 165 × 40 mm
Weight	850 g



CONNECTION DIAGRAM

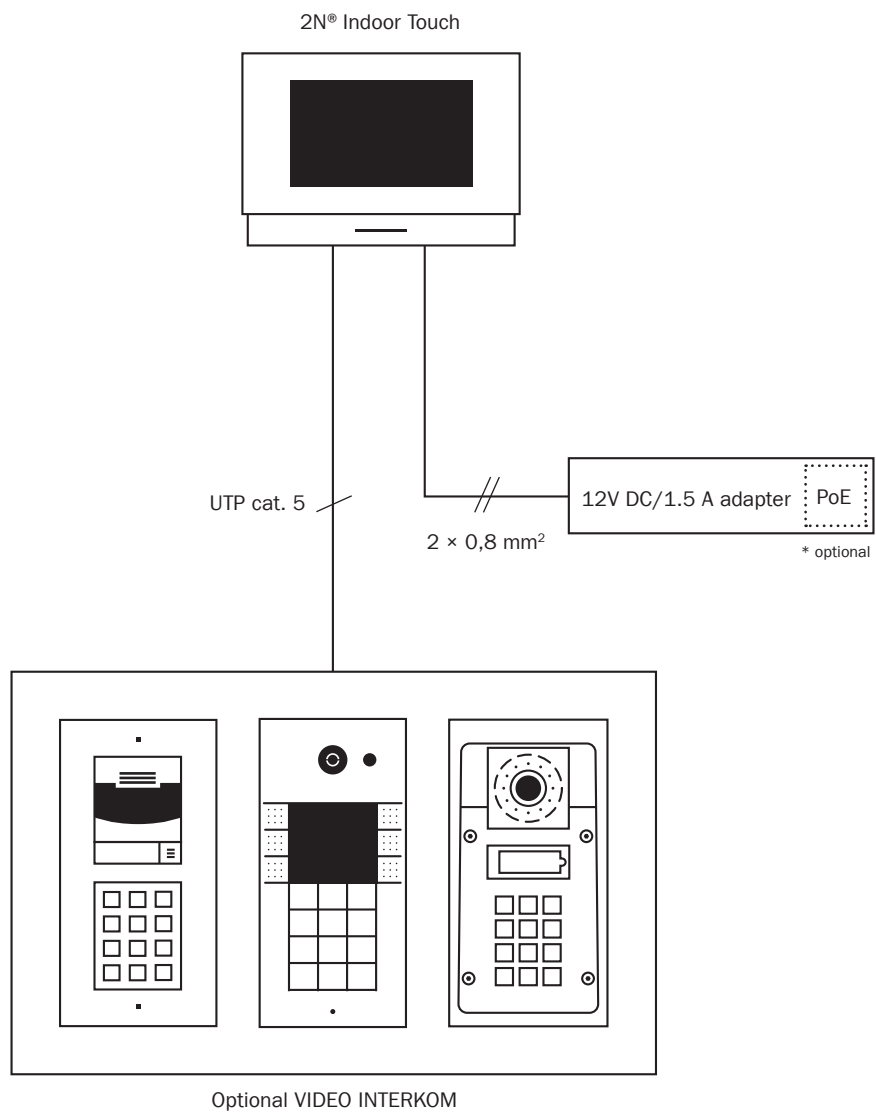

Analogue intercoms

2N® Helios Vario

TECHNICAL PARAMETERS

Telephone part	Value	Conditions
Minimum line current	15 mA	off the hook
Minimum line voltage	20 V	off the hook
DC attenuation of voltage off the hook	< 8 V < 16 V	I = 25 mA I = 50 mA
Leakage on the hook	< 25 μ A	U = 60 V
Impedance off the hook	220 Ω + 820 Ω paral. 115 nF	20 to 60 mA
Reflective attenuation	> 10 dB	20 to 60 mA
Bandwidth	300 to 3500 Hz	20 to 60 mA
Impedance during ringing	> 2 k Ω C = 470 nF	25 to 50 Hz
Sensitivity of ringing detection	10 to 20 V	25 to 50 Hz
Reaction time to ringing	adjustable	
Pulse dialling	40 / 60 ms	20 to 60 mA
Level of pulse dialling	-6 and -8 dB \pm 2 dB	20 to 60 mA
Sensitivity of tone dialling receiver	Min. -40 dB	20 to 60 mA
Sensitivity of dial tone detection	Min. -40 dB	350–500 Hz
Speed of engaged tone detection	adjustable	350–500 Hz
Speed of continuous tone detection	adjustable	350–500 Hz
Speed of ringing tone detection	adjustable	350–500 Hz
Overvoltage resilience – congruent	1000 V	8 / 20 μ s
Overvoltage resilience – between wires A, B	1000 V	8 / 20 μ s

Other parameters	Value
Switch – max. voltage	48 V AC, DC
Switch – min. voltage	9 V AC, DC
Switch – max. current	2 A AC, DC
Illumination – nominal voltage	12 V
Illumination – max. voltage	24 V
Illumination – consumption	max. 1 A
Range of operating temperatures	-20 to + 60 °C
Cover level	IP 53
Dimensions (1 module)	210 \times 100 \times 29 mm (h \times w \times d)
Weight	max. 500 g



CONNECTION DIAGRAM

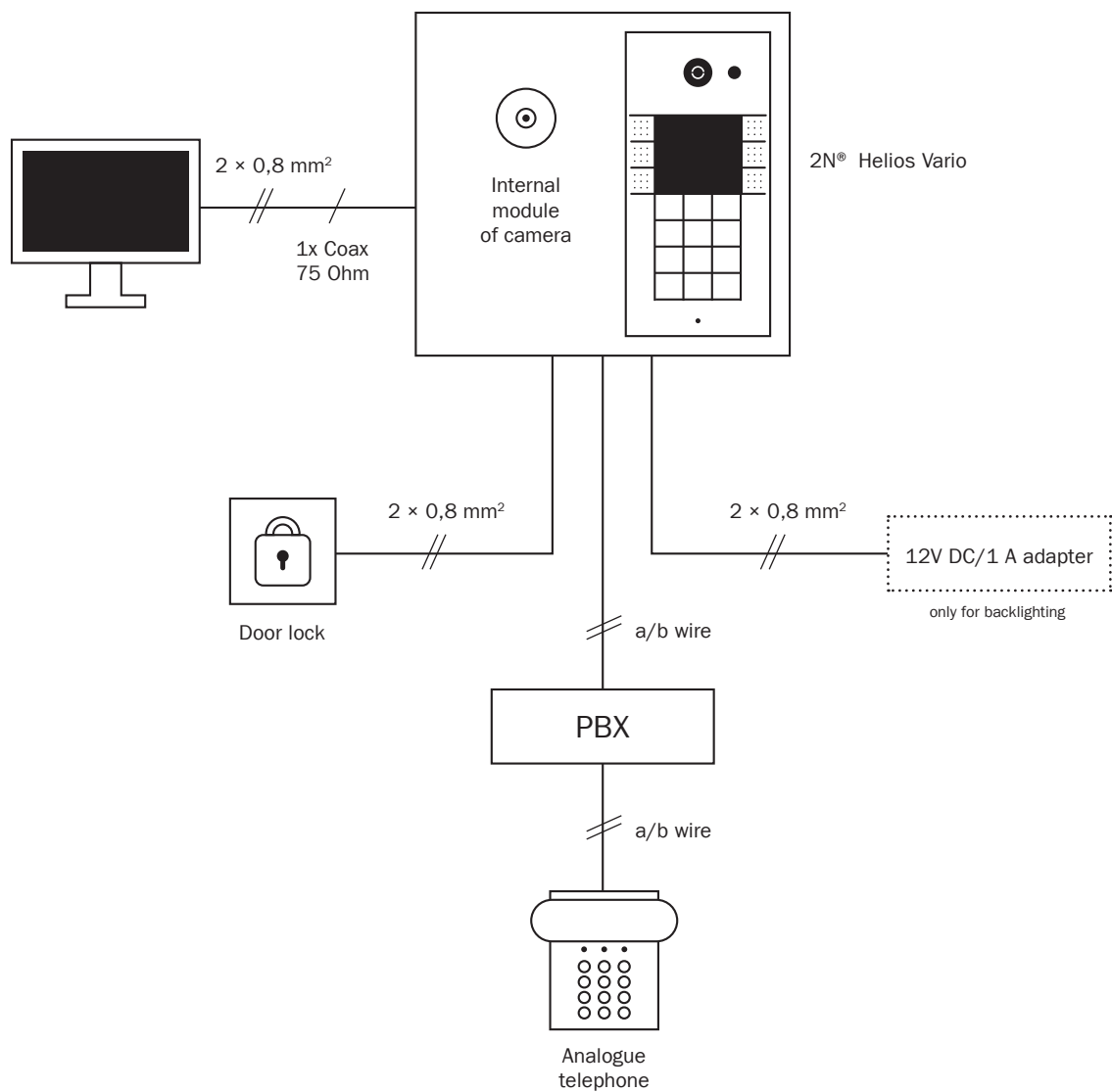

2N® Helios Force

TECHNICAL PARAMETERS

Telephone part	Value	Conditions
Minimum line current	15 mA	off the hook
Minimum line voltage	20 V	off the hook
DC attenuation of voltage off the hook	< 8 V < 16 V	I = 25 mA I = 50 mA
Leakage on the hook	< 25 µA	U = 60 V
Impedance off the hook	220 Ω + 820 Ω paral. 115 nF	20 to 60 mA
Reflective attenuation	> 10 dB	20 to 60 mA
Bandwidth	300 to 3500 Hz	20 to 60 mA
Impedance during ringing	> 2 kΩ C = 470 nF	25 to 50 Hz
Sensitivity of ringing detection	10 to 20 V	25 to 50 Hz
Reaction time to ringing	adjustable	
Pulse dialling	40 / 60 ms	20 to 60 mA
Level of pulse dialling	-6 and -8 dB ± 2 dB	20 to 60 mA
Sensitivity of tone dialling receiver	Min. -40 dB	20 to 60 mA
Sensitivity of dial tone detection	Min. -40 dB	350–500 Hz
Speed of engaged tone detection	adjustable	350–500 Hz
Speed of continuous tone detection	adjustable	350–500 Hz
Speed of ringing tone detection	adjustable	350–500 Hz
Overvoltage resilience – congruent	1000 V	8 / 20 µs
Overvoltage resilience – between wires A, B	1000 V	8 / 20 µs

Other parameters	Value
Switch – max. voltage	48 V AC, DC
Switch – min. voltage	9 V AC, DC
Switch – max. current	2 A AC, DC
Illumination – nominal voltage	12 V
Illumination – max. voltage	14 V
Illumination – consumption	max. 150 mA
Additional amplifier – consumption	max. 100 mA

Buttons

Button finish	Buttons with backlit nameplates
Number of buttons	1 to 4

Audio

Microphone	1 integrated microphone
Amplifier	amplifier 0,5W output

Mechanical properties

Cover	Robust aluminium casting
Operating temperature	-25°C – 55°C
Operating relative humidity	10% – 95% (non-condensing)
Storage temperature	-40°C – 70°C
Dimensions	217 × 109 × 83 mm 242 × 136 × 83 mm with frame
Weight	net max. 2 kg / gross max. 2,5 kg
Cover rating	IP65



CONNECTION DIAGRAM

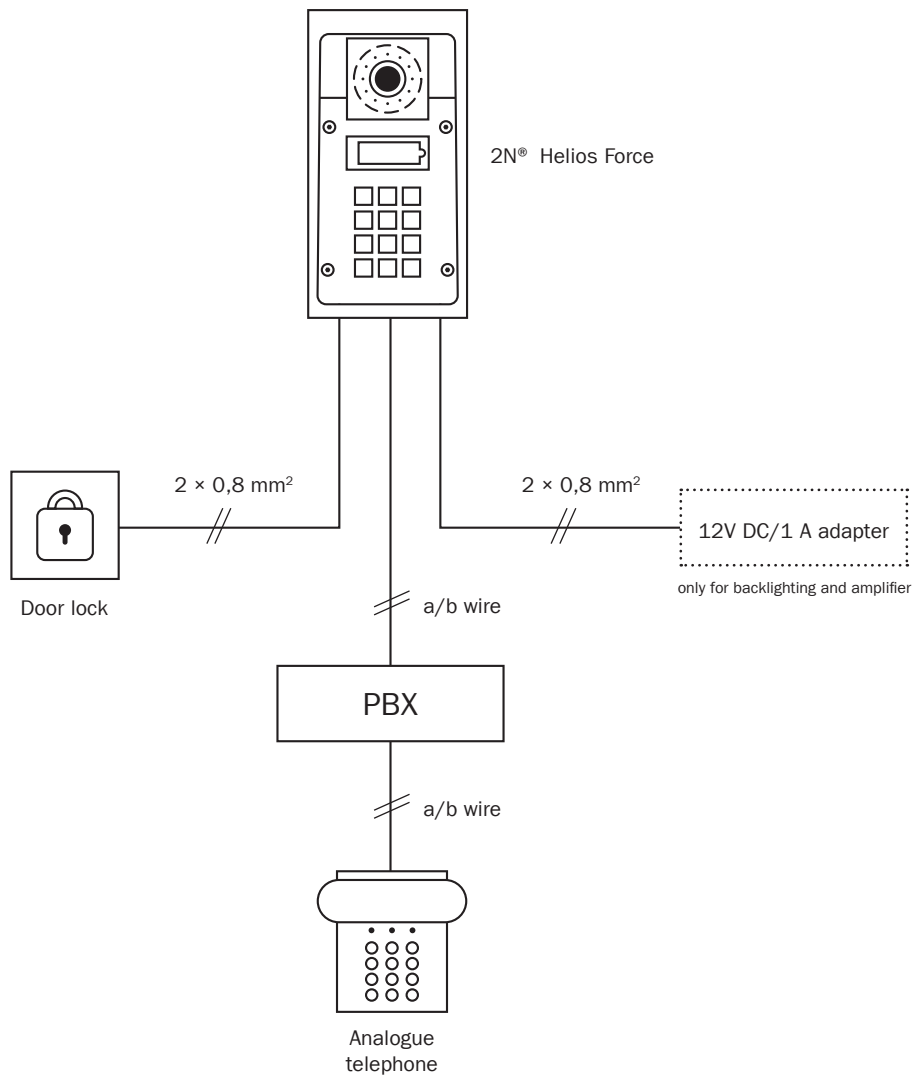

2N[®] Helios Safety

TECHNICAL PARAMETERS

Telephone part	Value	Conditions
Minimum line current	15 mA	off the hook
Minimum line voltage	20 V	off the hook
DC attenuation of voltage off the hook	< 8 V < 16 V	I = 25 mA I = 50 mA
Leakage on the hook	< 25 μ A	U = 60 V
Impedance off the hook	220 Ω + 820 Ω paral. 115 nF	20 to 60 mA
Reflective attenuation	> 10 dB	20 to 60 mA
Bandwidth	300 to 3500 Hz	20 to 60 mA
Impedance during ringing	> 2 k Ω C = 470 nF	25 to 50 Hz
Sensitivity of ringing detection	10 to 20 V	25 to 50 Hz
Reaction time to ringing	adjustable	
Pulse dialling	40 / 60 ms	20 to 60 mA
Level of pulse dialling	-6 and -8 dB \pm 2 dB	20 to 60 mA
Sensitivity of tone dialling receiver	Min. -40 dB	20 to 60 mA
Sensitivity of dial tone detection	Min. -40 dB	350–500 Hz
Speed of engaged tone detection	adjustable	350–500 Hz
Speed of continuous tone detection	adjustable	350–500 Hz
Speed of ringing tone detection	adjustable	350–500 Hz
Over current resilience – congruent	1000 V	8 / 20 μ s
Overvoltage resilience – between wires A, B	1000 V	8 / 20 μ s

Other parameters	Value
Switch – max. voltage	48 V AC, DC
Switch – min. voltage	9 V AC, DC
Switch – max. current	2 A AC, DC
Illumination – nominal voltage	12 V
Illumination – max. voltage	14 V
Illumination – consumption	max. 150 mA
Additional amplifier – consumption	max. 100 mA



CONNECTION DIAGRAM

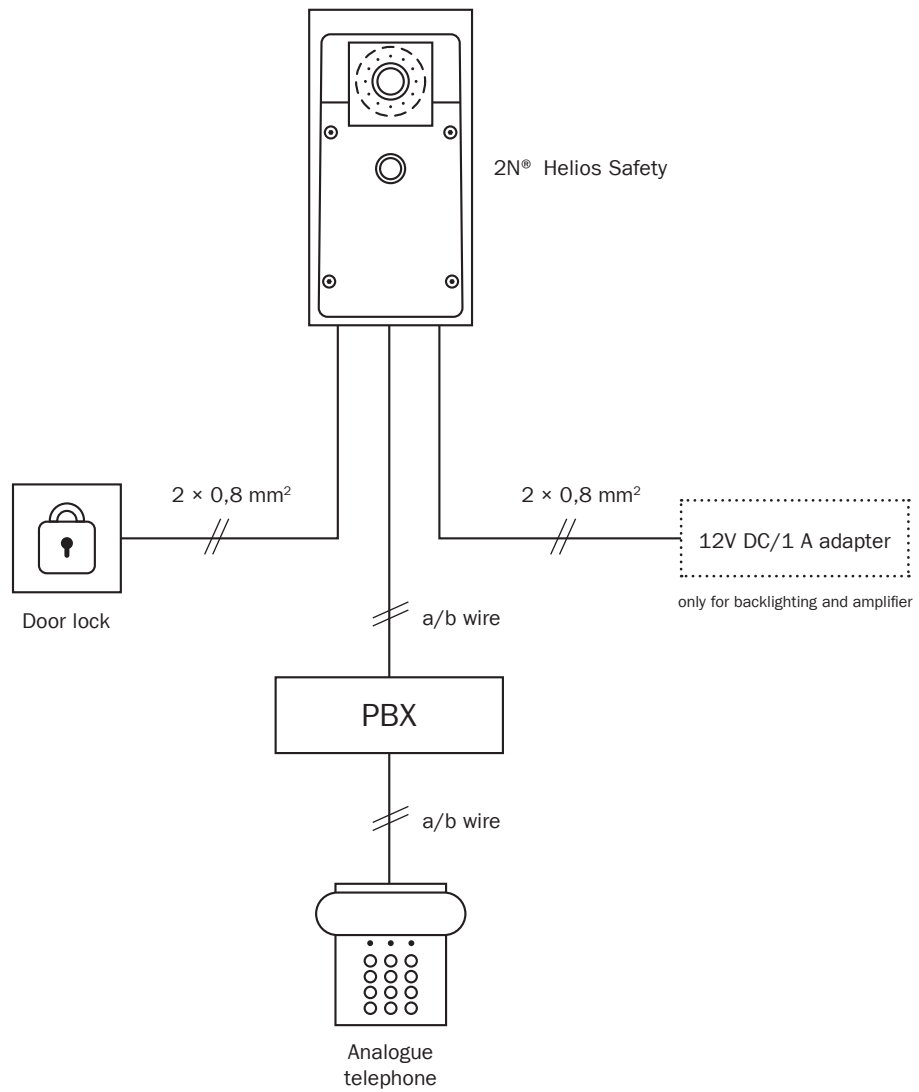

2N® Helios Uni

TECHNICAL PARAMETERS

Telephone part	Value	Conditions
Minimum line current	15mA	off the hook
Minimum line voltage	20V	off the hook
DC attenuation of voltage off the hook	< 8V < 16V	I = 25mA I = 50mA
Leakage on the hook	< 25µA	U = 60 V
Impedance off the hook	220Ω + 820Ω paral. 115nF	20 to 60mA
Reflective attenuation	> 10 dB	20 to 60mA
Bandwidth	300 to 3500Hz	20 to 60mA
Impedance during ringing	> 2kΩ C = 470nF	25 to 50Hz
Sensitivity of ringing detection	10 to 20V	25 to 50Hz
Reaction time to ringing	adjustable	
Pulse dialling	40 / 60ms	20 to 60mA
Level of pulse dialling	-6 and -8dB ± 2dB	20 to 60mA
Sensitivity of tone dialling receiver	Min. -40dB	20 to 60mA
Sensitivity of dial tone detection	Min. -40dB	350–500Hz
Speed of engaged tone detection	adjustable	350–500Hz
Speed of continuous tone detection	adjustable	350–500Hz
Speed of ringing tone detection	adjustable	350–500Hz
Over current resilience – congruent	1000V	8 / 20µs
Overvoltage resilience – between wires A, B	1000V	8 / 20µs

Other parameters	Value
Switch – max. voltage	48V AC, DC
Switch – min. voltage	9V AC, DC
Switch – max. current	2A AC, DC
Illumination – nominal voltage	12V
Illumination – max. voltage	14V
Illumination – consumption	max. 5mA



CONNECTION DIAGRAM

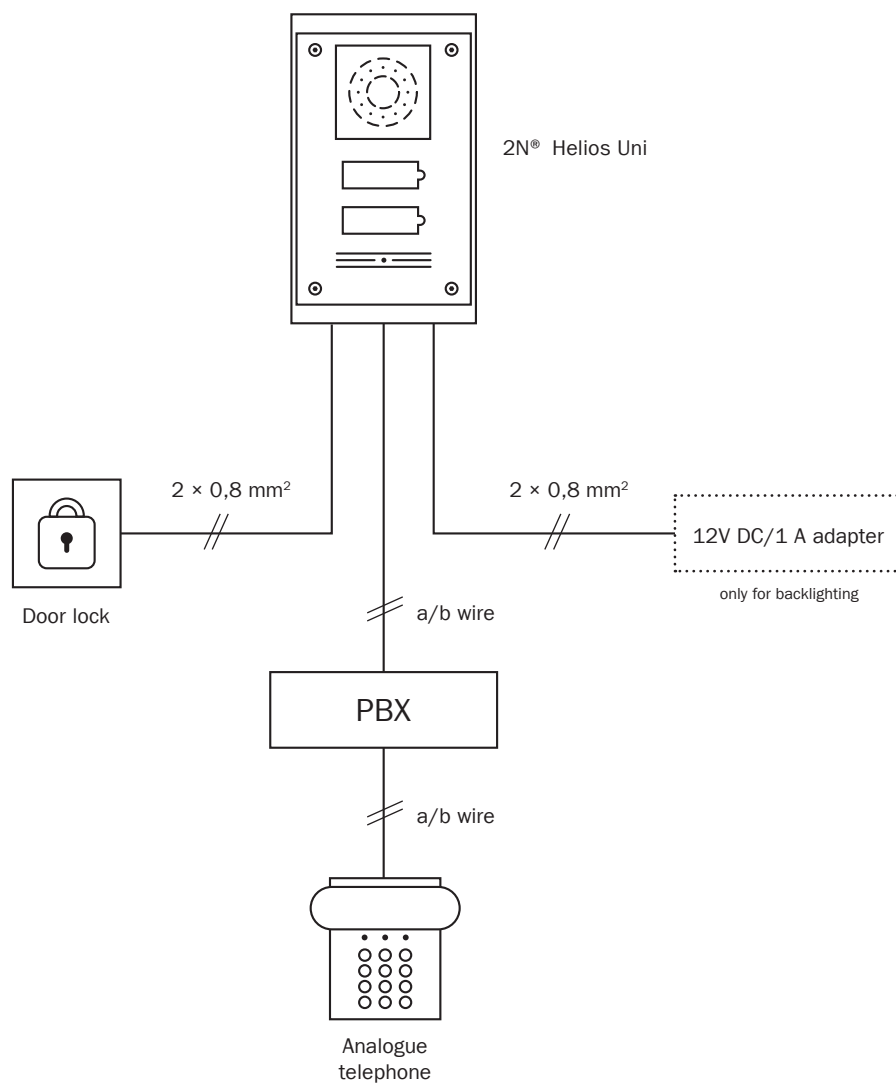

IP PA systems

2N® NetSpeaker

TECHNICAL PARAMETERS

Interface

Power from external source	12V DC / 2A
Power from LAN	PoE IEEE 802.3af
LAN connection	RJ-45 connector on rear panel 10/100BASE-TX with function Auto-MDIX
Digital output	1× Relay output, 24V 1A AC/DC, galvanically insulated
Digital input	1× Digital input, 5 to 24V DC, galvanically uninsulated
Earphone/line out	1× STEREO 3,5 mm jack on front panel
Expansion of internal memory	1× Slot for MicroSD memory card on front panel
Output of powerful amplifier	4× terminal on rear panel, STEREO/MONO with autodetection

Control and signalling

Signalling state	1× RGB LED on front panel
Local control	2× button on front panel
Remote control	1× Infrared detector on front panel

Audio

Speaker impedance	4–16 Ω		
Amplifier performance	Speaker	12V/2A	PoE
	2× 4Ω STEREO	2× 2,5W	2× 2,5W
	2× 8Ω STEREO	2× 7W	2× 4W
	2× 16Ω STEREO	2× 4W	2× 4W
	4Ω MONO	1× 14W	1× 8W
	8Ω MONO	1× 8W	1× 8W
Frequency range	20Hz–20kHz (± 0,5 dB)		
Harmonic distortion	0,05% @ 1kHz		
Signal-to-noise ratio	91 dB		
Audio compression	MPEG-1 Audio Layer II (MP2)		
Bandwidth	32–320 kbps		

Mechanical properties

Dimensions	105 × 34 × 86 mm
Dimensions (with L-profiles)	130 × 34 × 86 mm
Weight	300 g



CONNECTION DIAGRAM

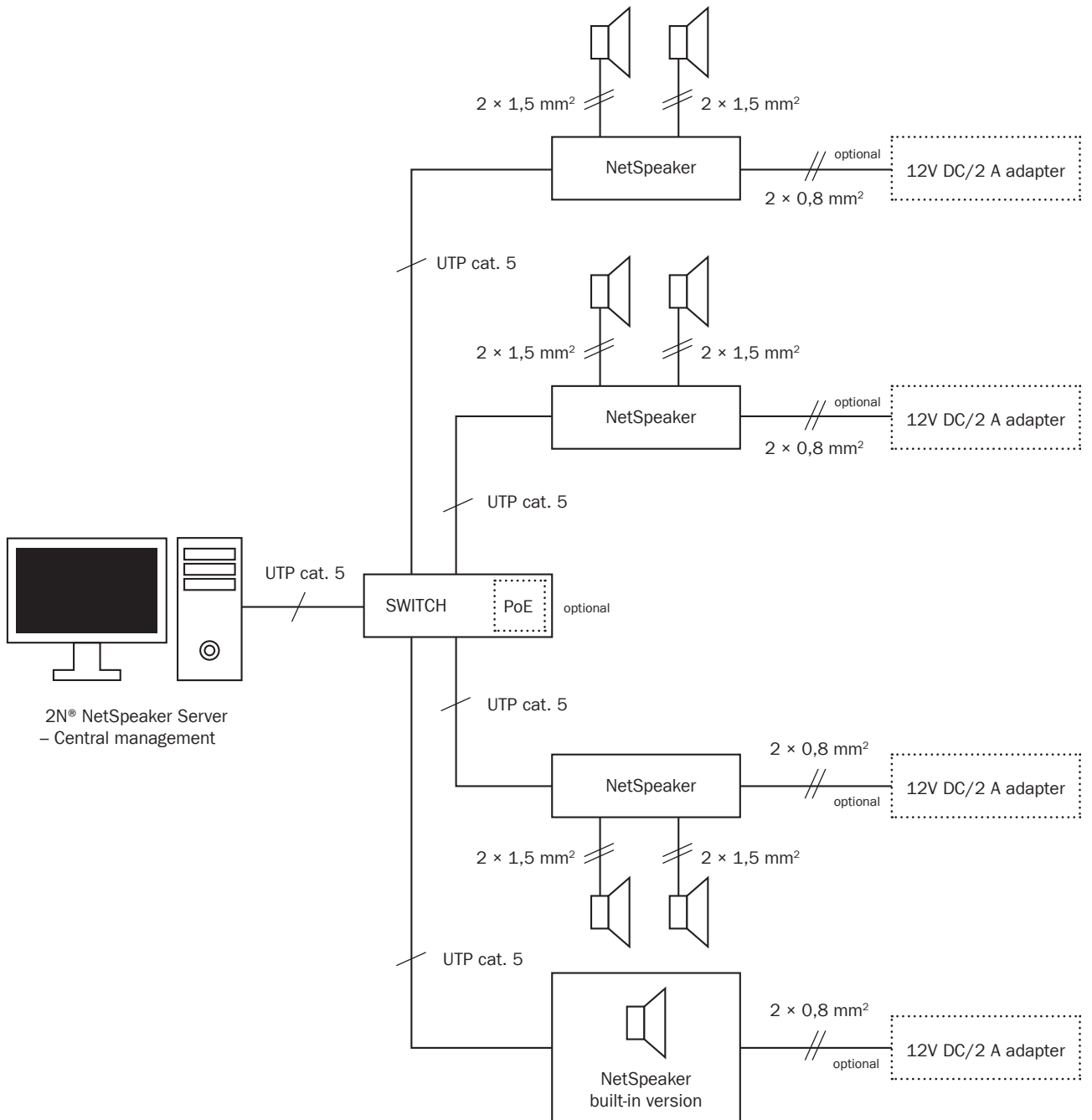

* Power from external 12V adapter or POE

2N® SIP Speaker

TECHNICAL PARAMETERS

Interface

Power from external source	12V DC / 2A
Power from LAN	PoE IEEE 802.3af
LAN connection	RJ-45 connector on rear panel 10/100BASE-TX with function Auto-MDIX
Digital output	1× Relay output, 24V 1A AC/DC, galvanically insulated
Digital input	1× Digital input, 5 to 24V DC, galvanically uninsulated
Earphone/line out	1× STEREO 3,5 mm jack on front panel
Microphone/Line in	1× STEREO 3,5 mm jack on front panel
Output of powerful amplifier	4× terminal on rear panel, STEREO/MONO with auto detection

Control and signalling

Signalling state	3× RGB LED on front panel
Local control	3× button on front panel
Remote control	1× Infrared detector on front panel

Audio

Speaker impedance	4–8Ω		
Amplifier performance	Speaker	12V/2A	PoE
	2× 4Ω STEREO	2× 10W	2× 5W
	2× 8Ω STEREO	2× 9W	2× 5W
	4Ω MONO	1× 18W	1× 10W
	8Ω MONO	1× 18W	1× 10W
Frequency range	20 Hz–20 kHz (± 0,5 dB)		
Harmonic distortion	0,05% @ 1 kHz		
Signal-to-noise ratio	91 dB		
Audio compression	MPEG-1 Audio Layer II (MP2)		
Bandwidth	32–320 kbps		
Audiocodices	G.711 (PCMA, PCMU), G.729 (Annex A, B), L16		

Mechanical properties

Dimensions	105 × 34 × 86 mm
Dimensions (with L-profiles)	130 × 34 × 86 mm
Weight	300 g



TECHNICAL PARAMETERS

SIP Speaker
built into speaker

Interface

Power from external source	12V DC / 2A
Power from LAN	PoE IEEE 802.3af
LAN connection	RJ-45 connector on rear panel 10/100BASE-TX with function Auto-MDIX
Digital output	Only external contact required
Digital input	1× Digital input, 5 to 24V DC, galvanically uninsulated
Output of powerful amplifier	6W

Control and signalling

3 buttons

Audio

Sound pressure level	100 dB
Frequency range	20 Hz–20 kHz (± 0,5 dB)
Harmonic distortion	0,05% @ 1 kHz
Signal-to-noise ratio	91 dB
Audiocodices	G.711 (PCMA, PCMU), G.729 (Annex A, B), L16

Mechanical properties

Dimensions	237 × 170 × 80 mm
Weight	1300 g

CONNECTION DIAGRAM

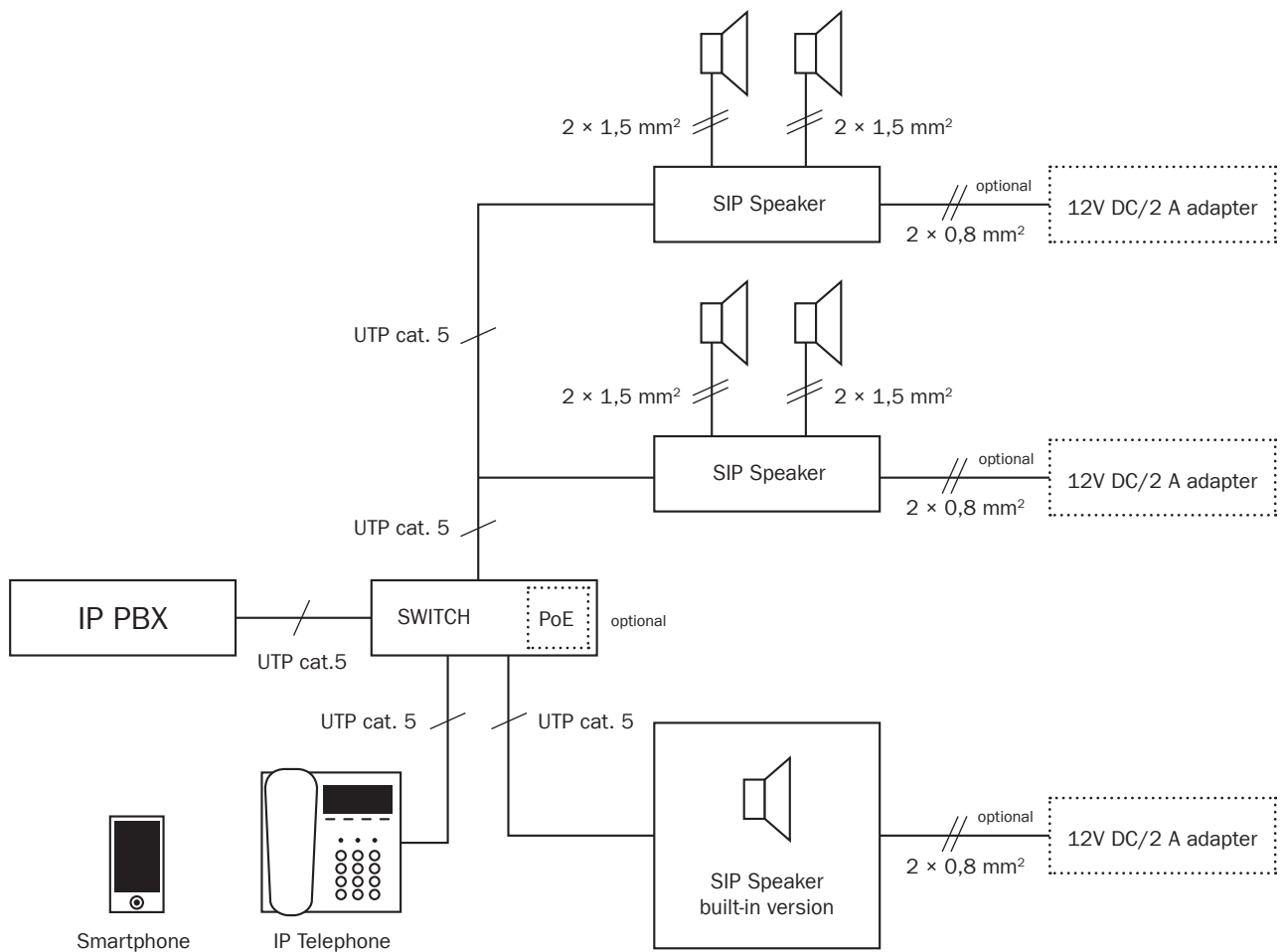

* Power from external 12V adapter or POE

2N® NetMic

TECHNICAL PARAMETERS

Power supply

	12 to 32 V, max. 1 A
	PoE in accordance with 802.3af standard

Buttons and captions

Dimensions of captions	39.6 mm width × 9 mm height
12x customizable buttons	zone selection for announcement zone selection with predefined message
Large button (speak)	25.5 mm × 12 mm
Small button (listen)	12 mm × 12 mm

Audio stream

	PCM, 44 100 kHz, 16 bit, Stereo
Speakers	2 built-in, stereo, power output 2 × 1 W
Main microphone input	Symmetrical, XLR, integrated phantom current of 24 V, DR 88 dB, THD+N -82 dB

Mechanical properties

Operating temperature	0–40 °C
Dimensions	209 × 65 × 143 mm



CONNECTION DIAGRAM

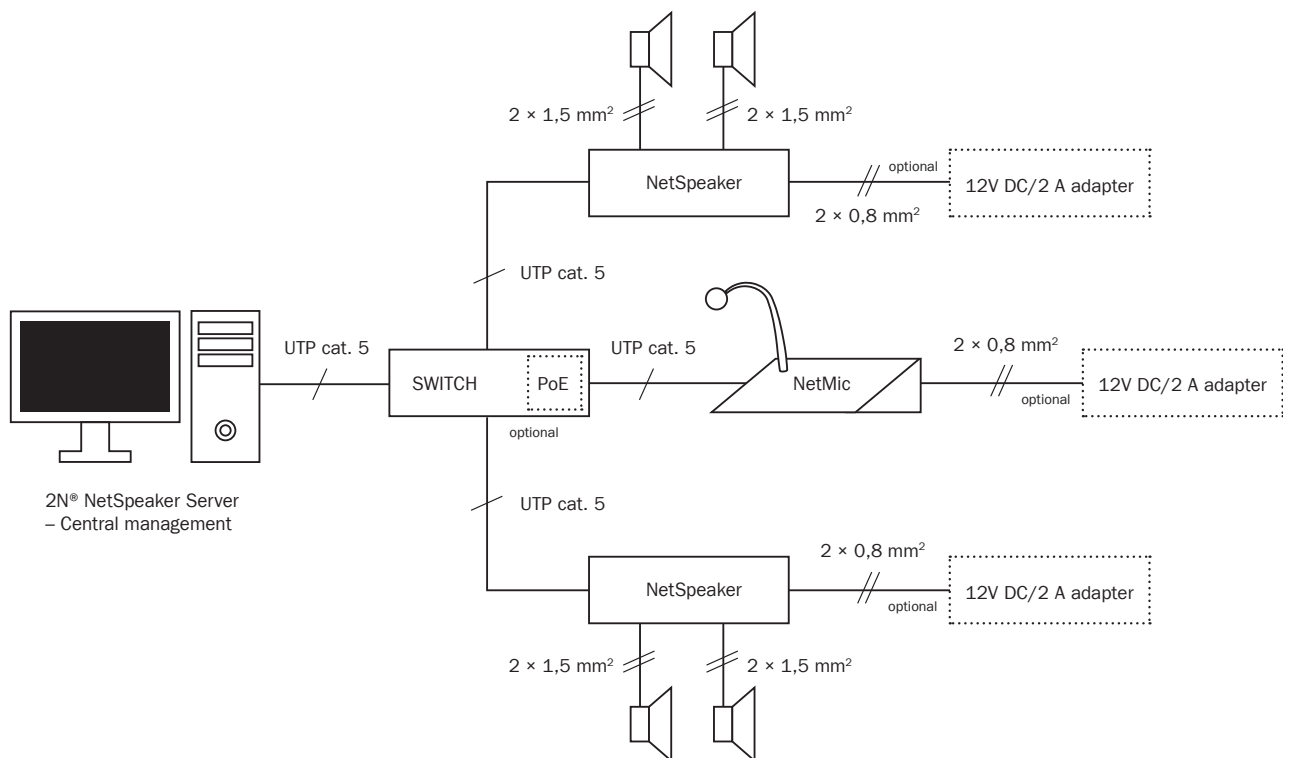

* Power from external 12V adapter or POE

Dimensions and fitting

2N® Helios IP Verso

IN-WALL 2 MODULES

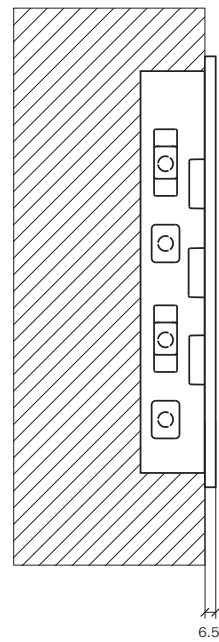
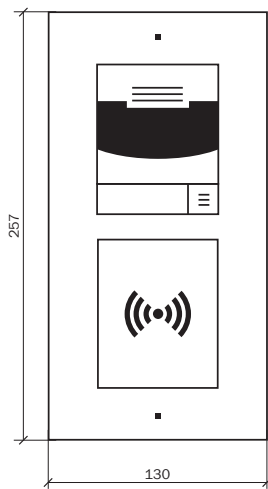

2× IN-WALL 2 MODULES

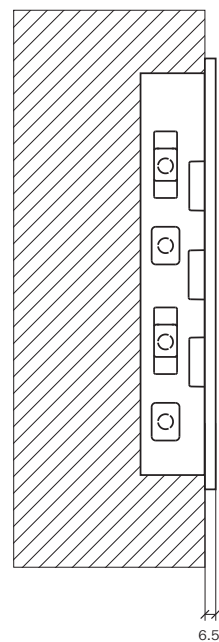
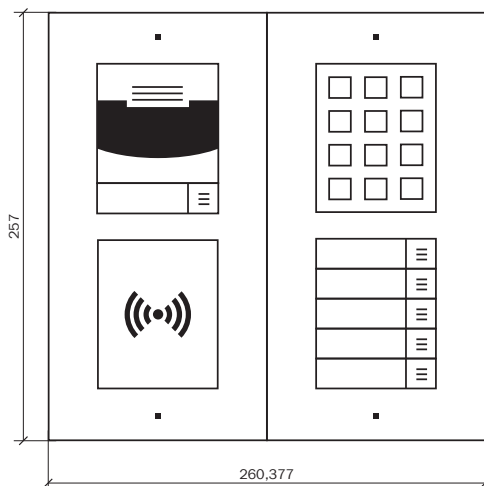

IN-WALL 3 MODULES

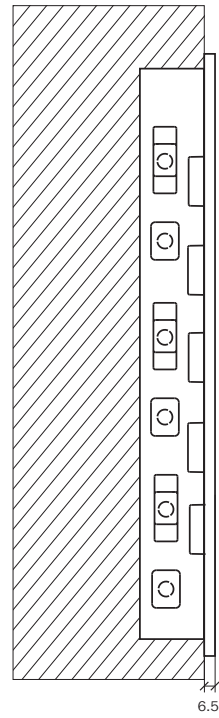
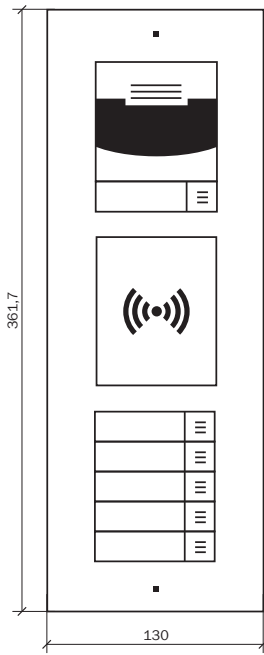

2× IN-WALL 3 MODULES

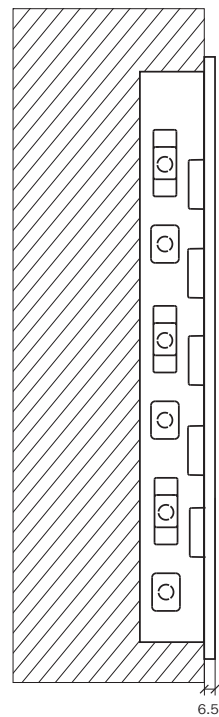
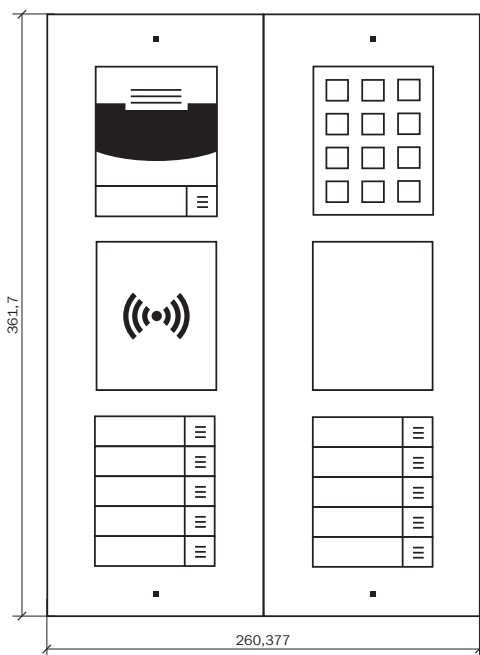

WALL-MOUNTED 2 MODULES

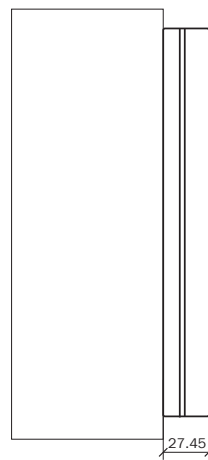
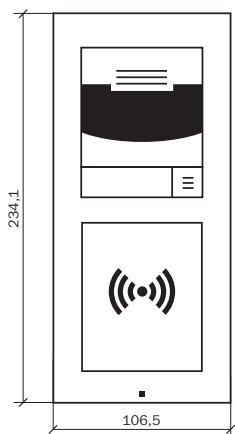

2x WALL-MOUNTED 2 MODULES

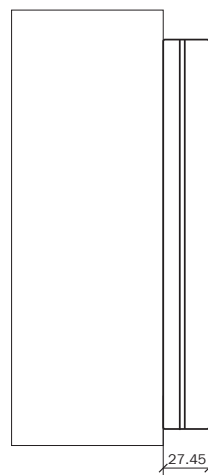
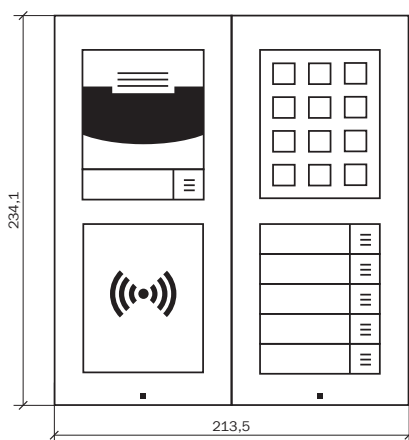

WALL-MOUNTED 3 MODULES

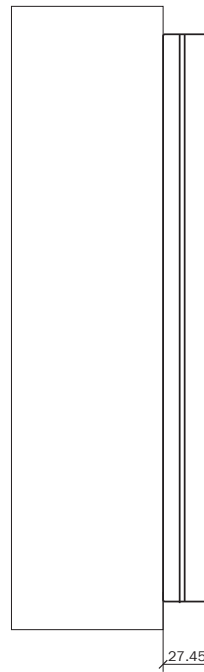
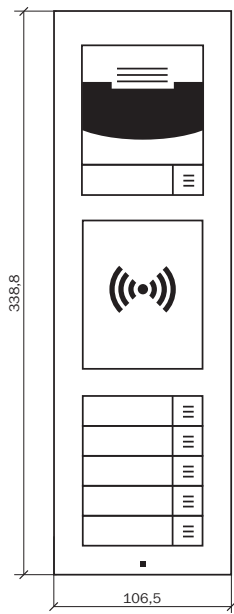

2x WALL-MOUNTED 3 MODULES

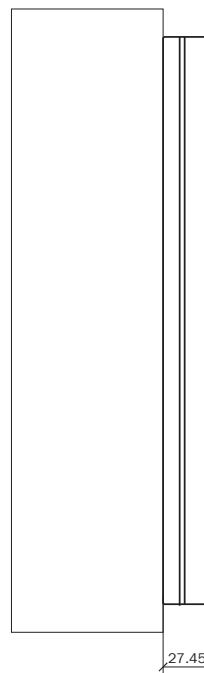
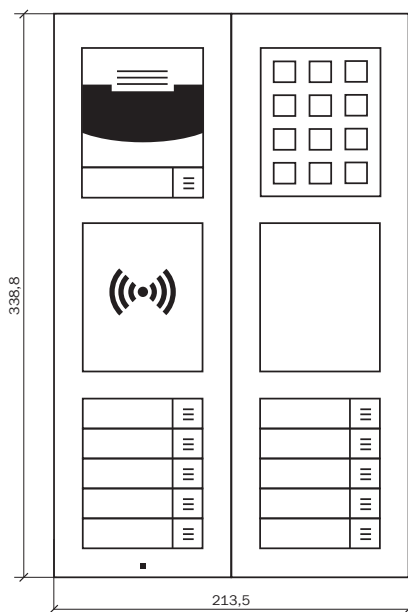

1 MODULE, WALL-MOUNTED

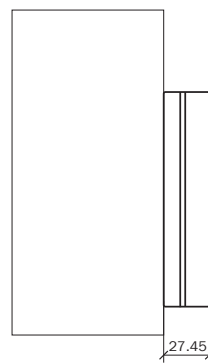
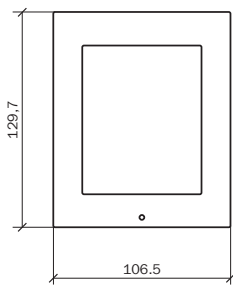

IN-WALL 1 MODULE

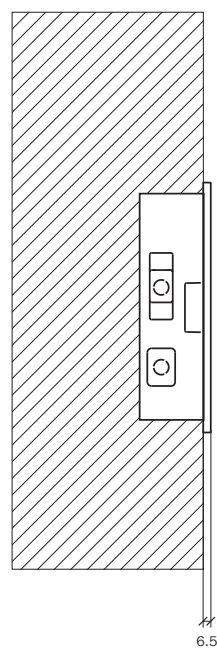
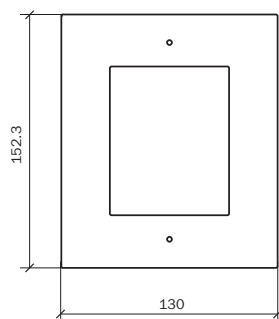

2N[®] Helios (IP) Vario

1 MODULE, FLUSH-MOUNTED

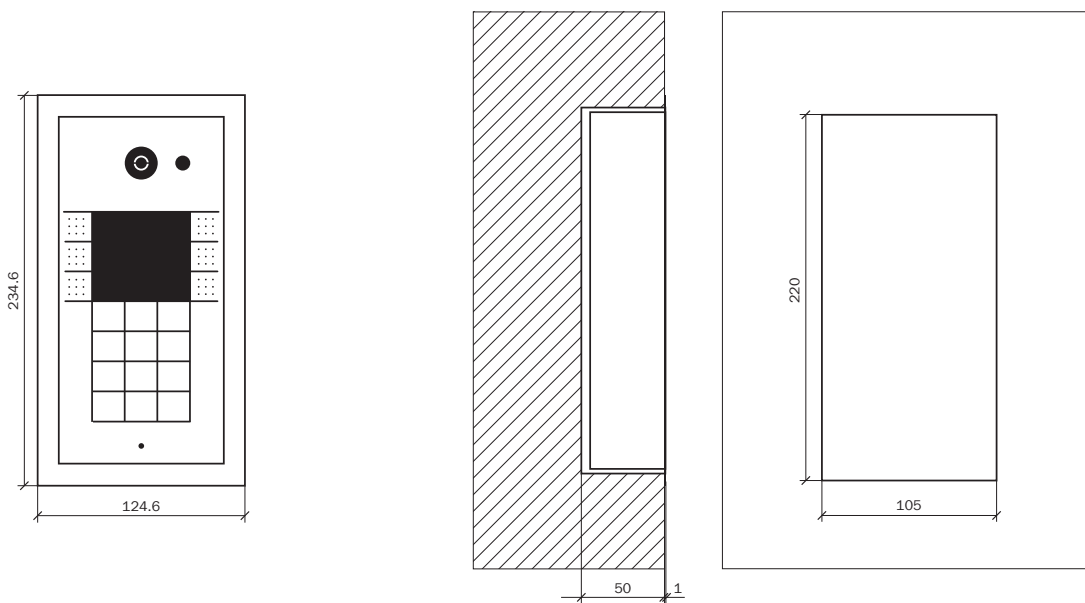

2 MODULES, FLUSH-MOUNTED

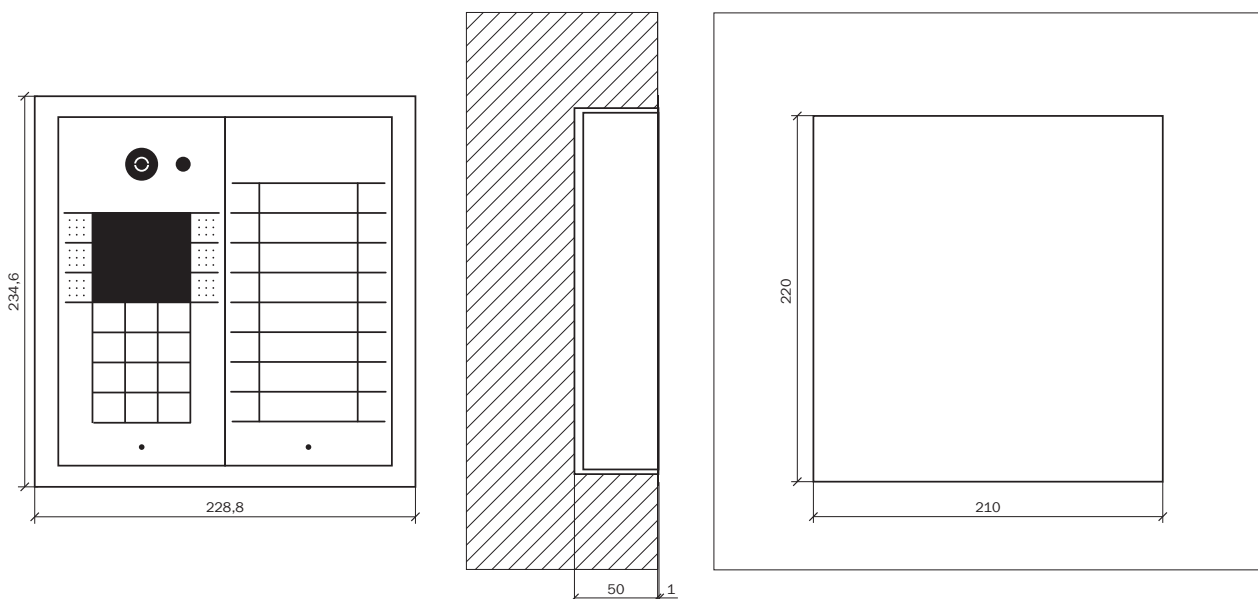

1 MODULE WITH SHELTER, FLUSH-MOUNTED

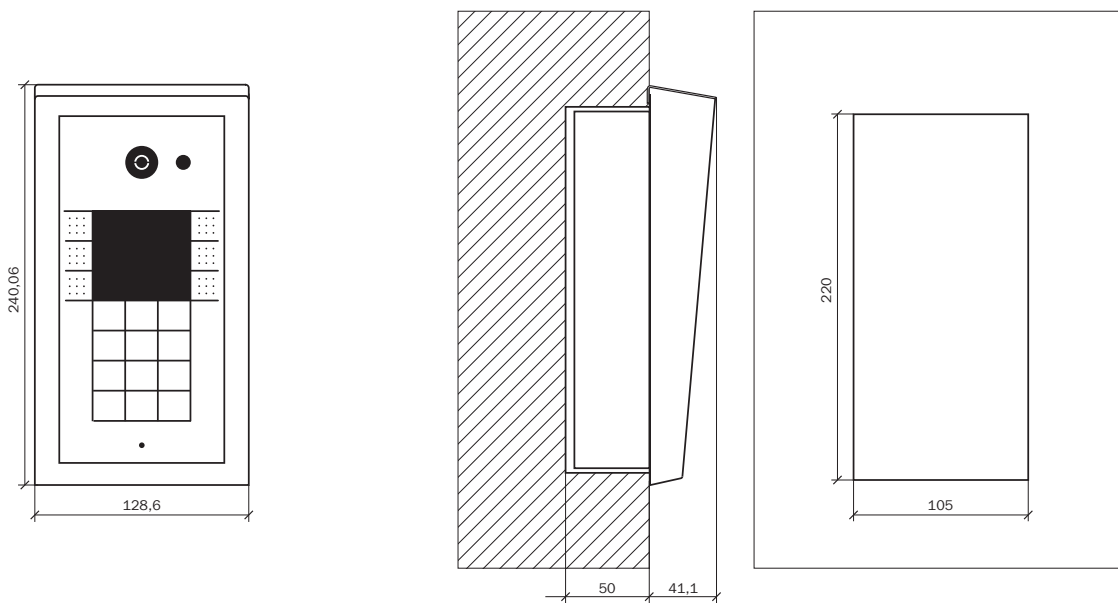

2 MODULES WITH SHELTER, FLUSH-MOUNTED

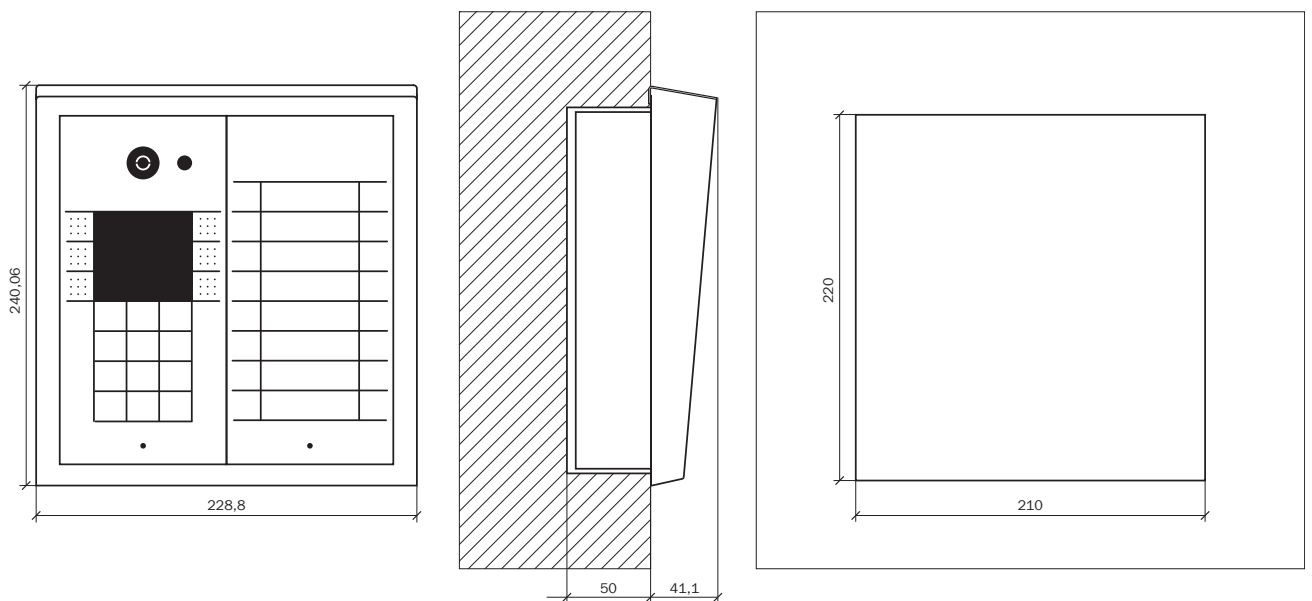

1 MODULE, WALL-MOUNTED

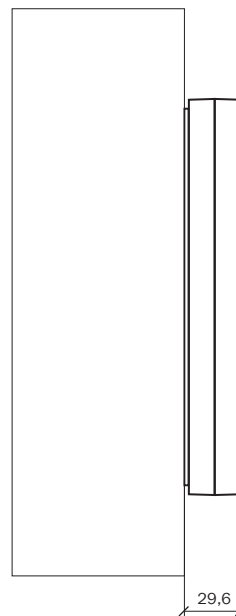
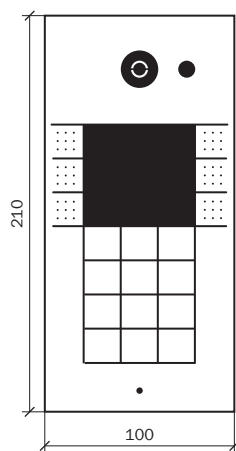

2 MODULES, WALL-MOUNTED

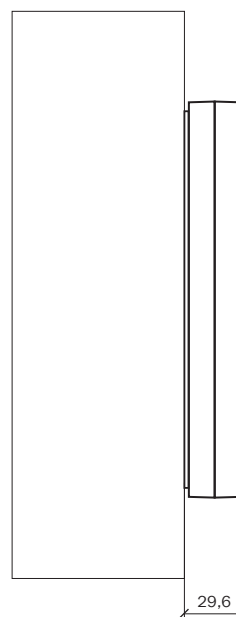
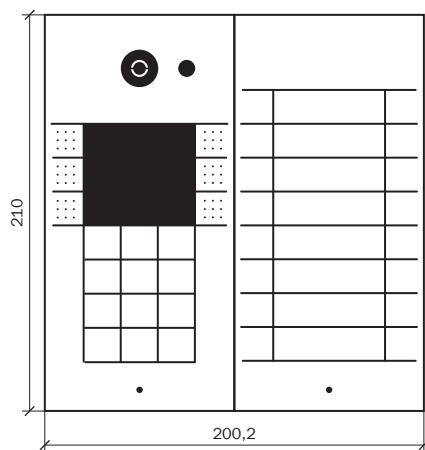

1 MODULE WITH SHELTER, WALL-MOUNTED

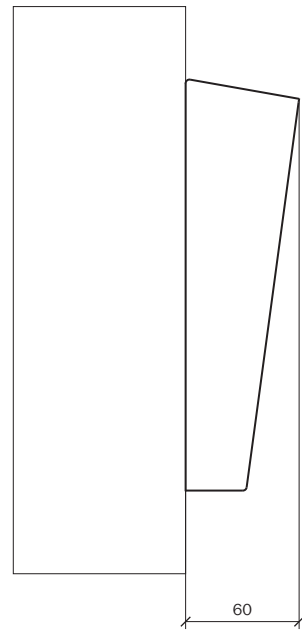
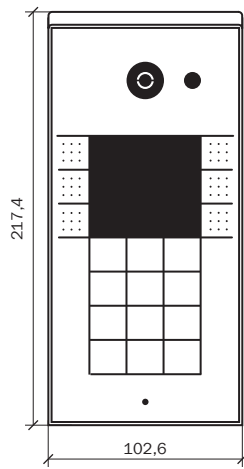

2 MODULES WITH SHELTER, WALL-MOUNTED

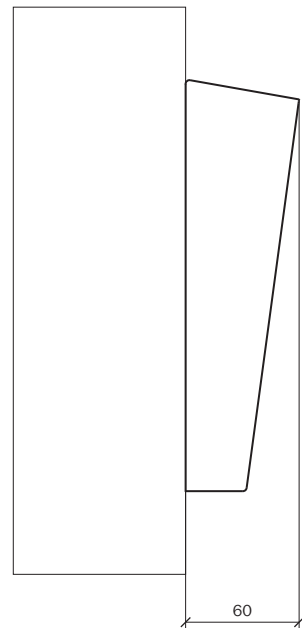
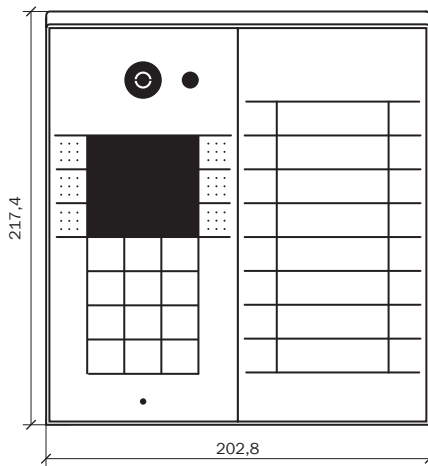

2N[®] Helios (IP) Force

FLUSH-MOUNTED WITHOUT BOX

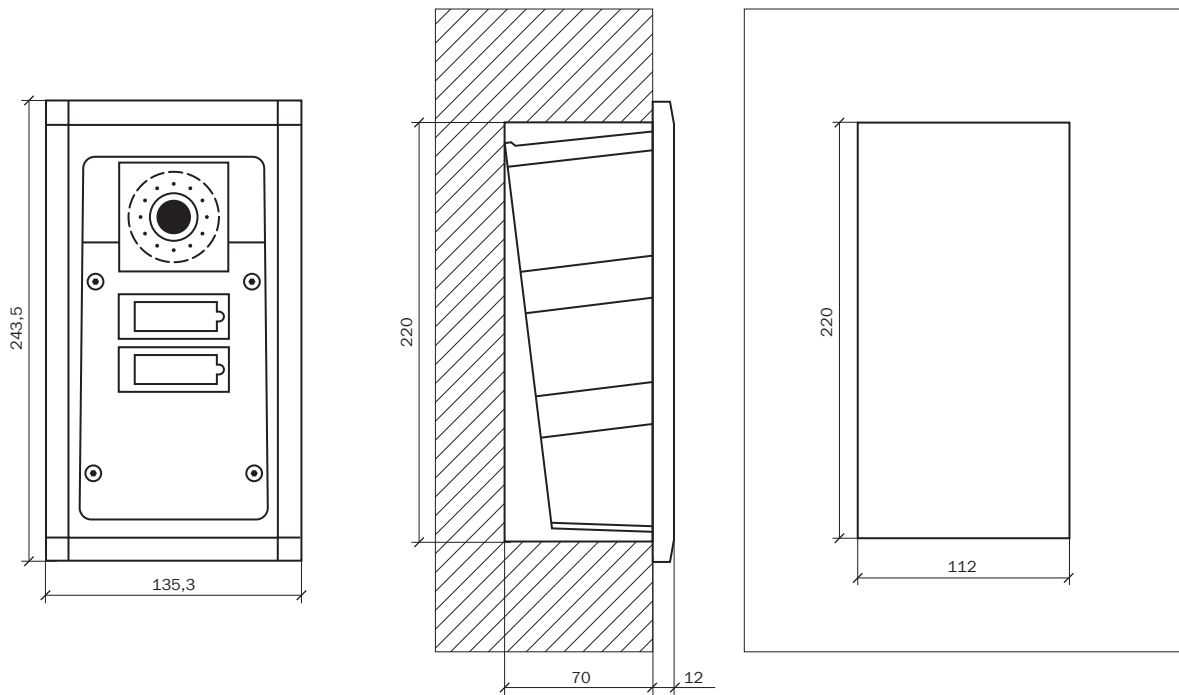

FLUSH-MOUNTED WITH BOX

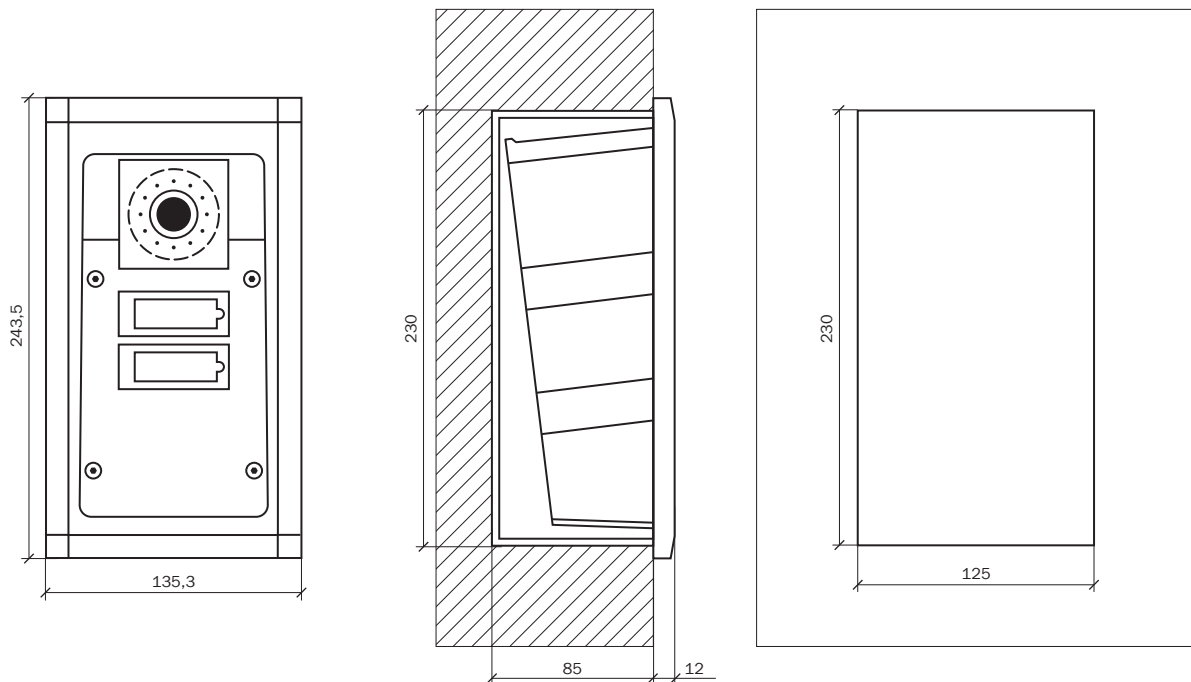

MOUNTING IN PLASTERBOARD

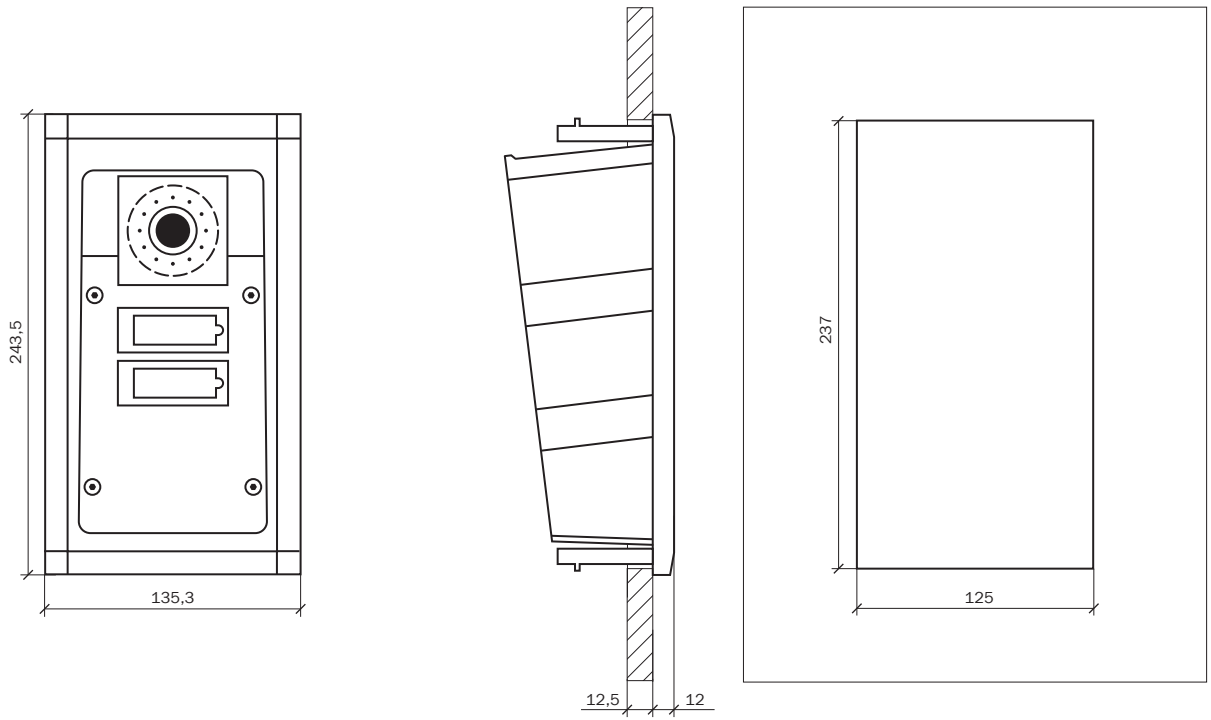

WALL-MOUNTED

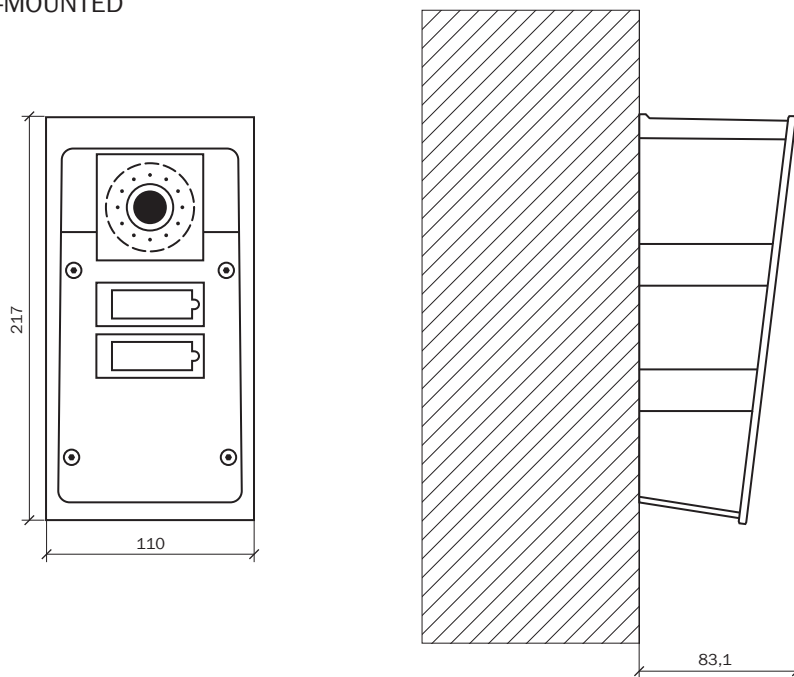

2N[®] Helios (IP) Safety

FLUSH-MOUNTED WITHOUT BOX

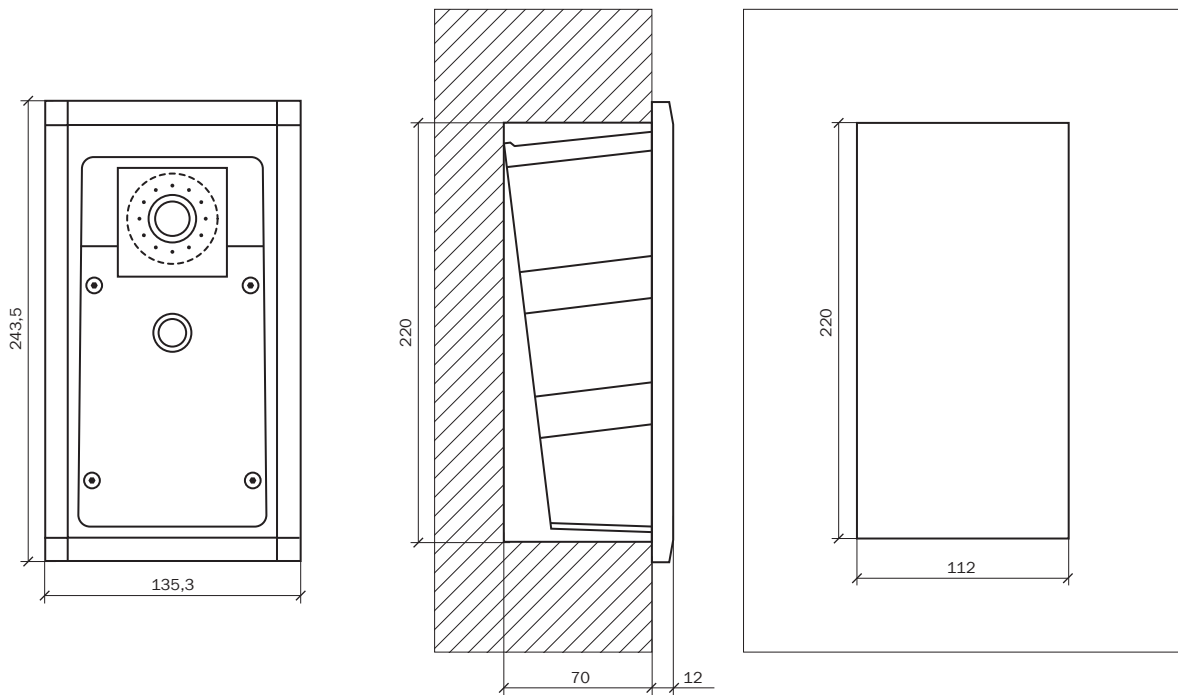

FLUSH-MOUNTED WITH BOX

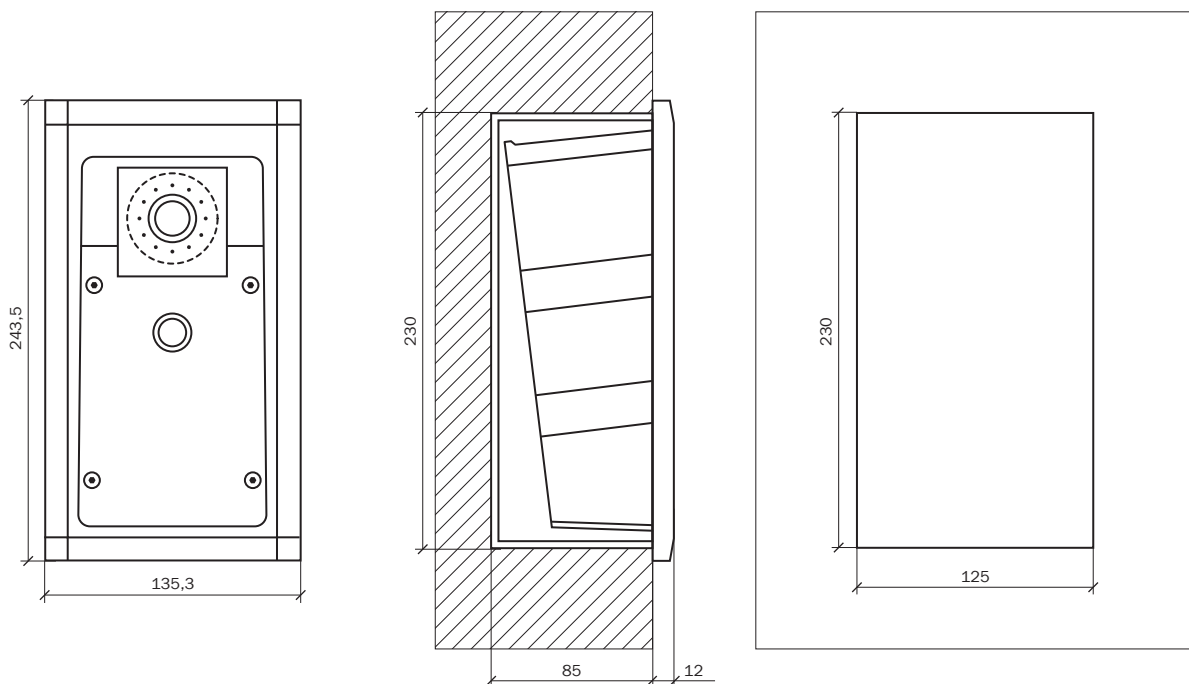

MOUNTING IN PLASTERBOARD

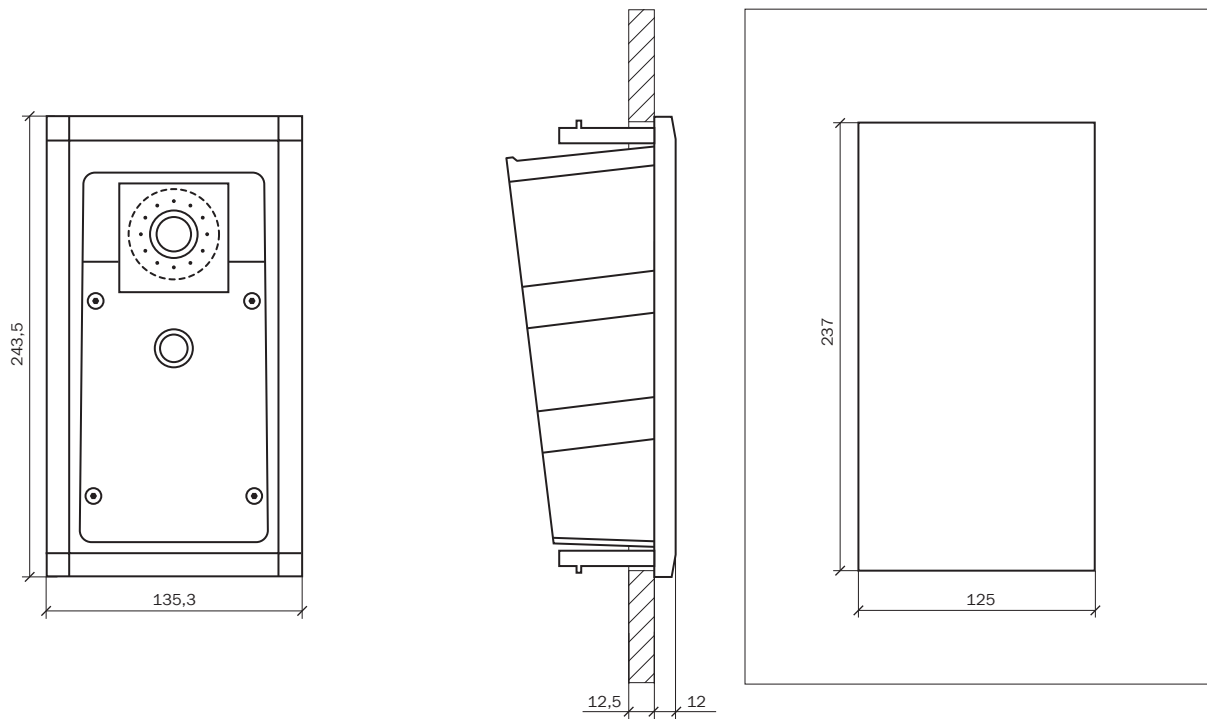

WALL-MOUNTED

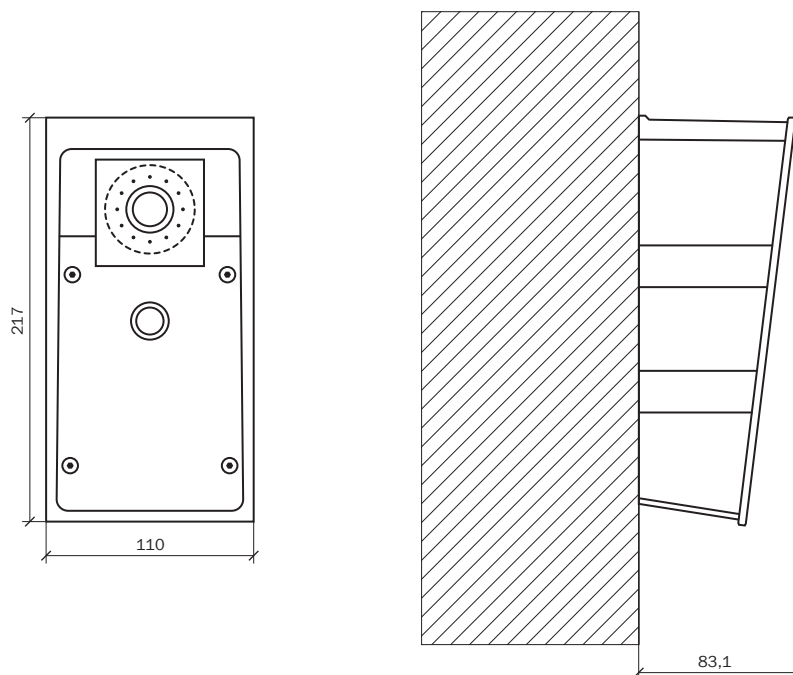

2N[®] Helios (IP) Uni

FLUSH-MOUNTED

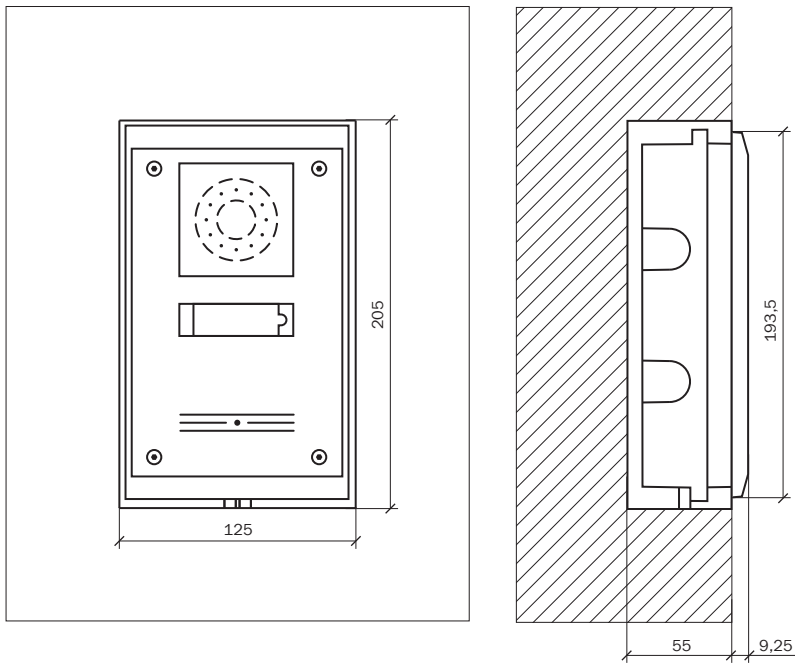

MOUNTING IN PLASTERBOARD

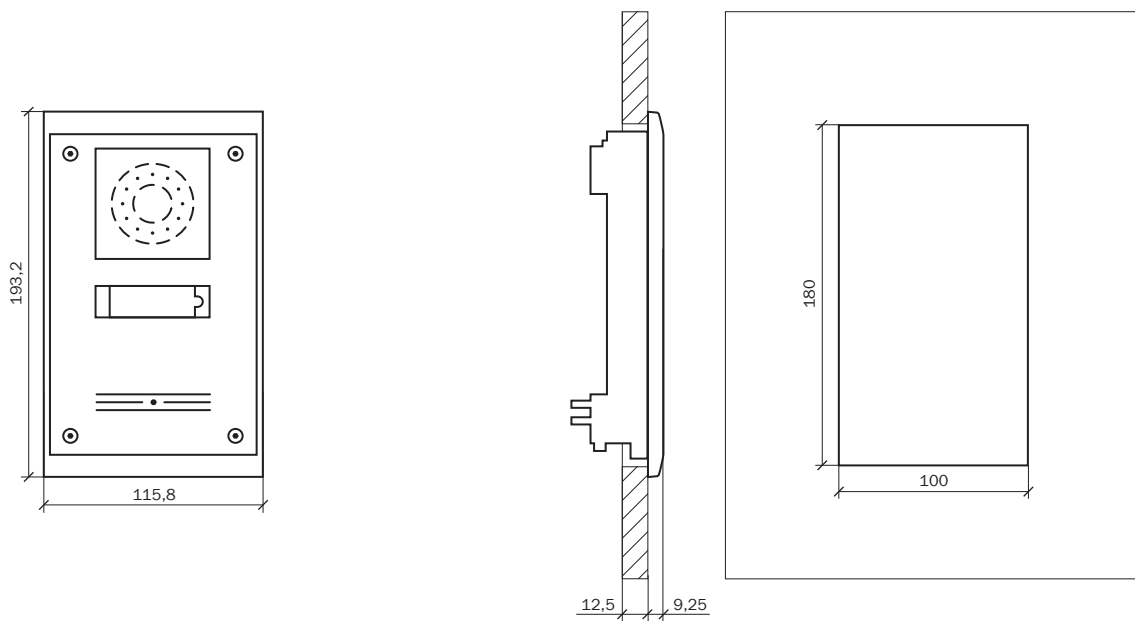

WALL-MOUNTED

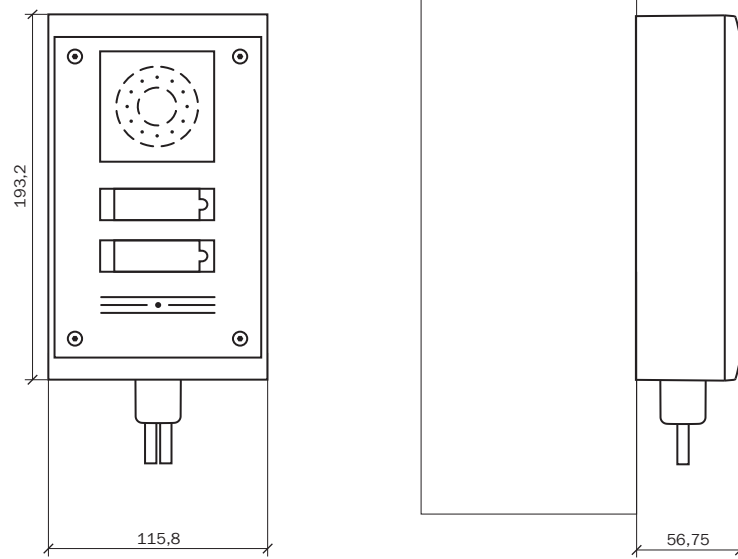

2N[®] NetSpeaker

WITHOUT LUGS

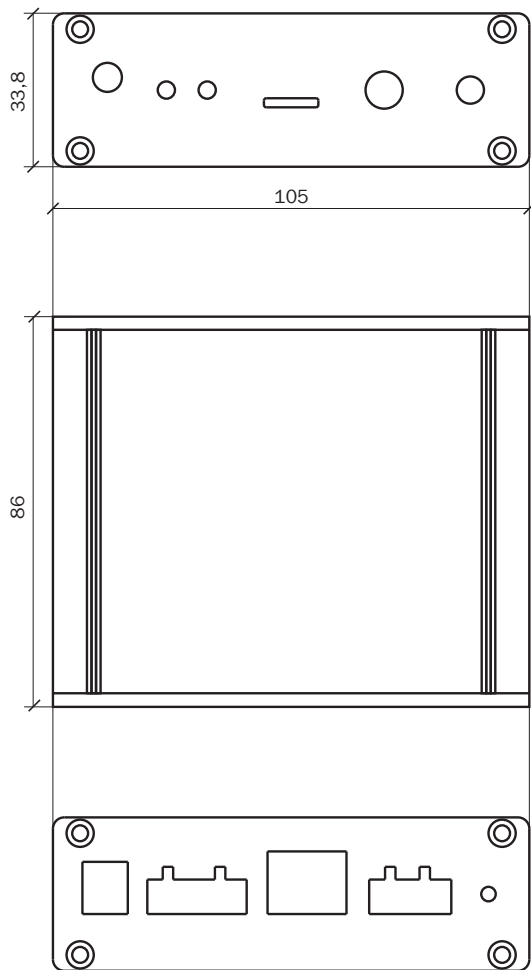

WITH LUGS

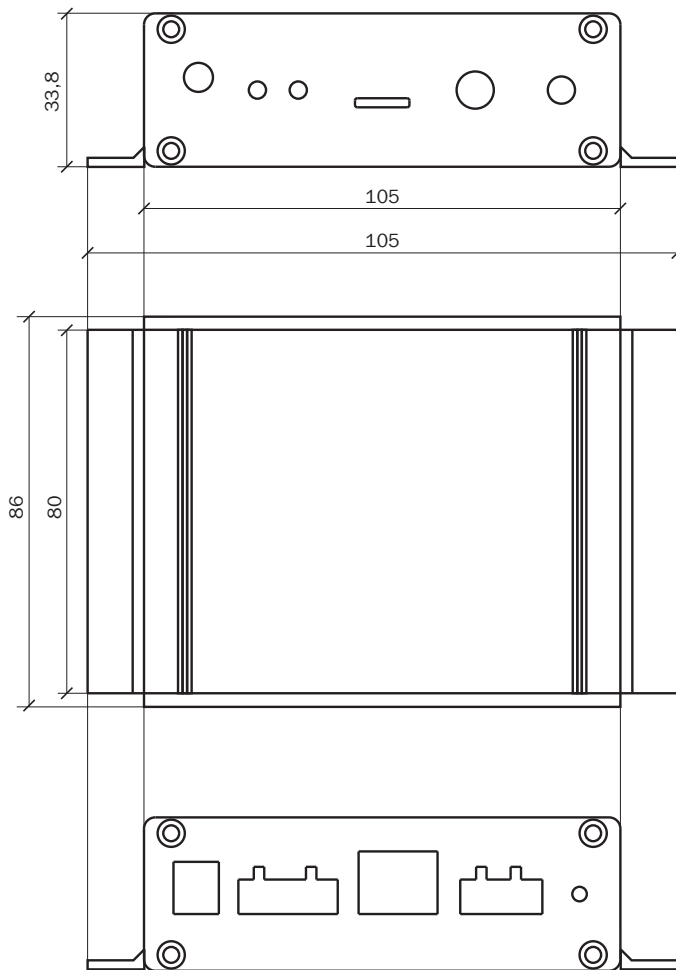

2N[®] SIP Speaker

WITHOUT LUGS

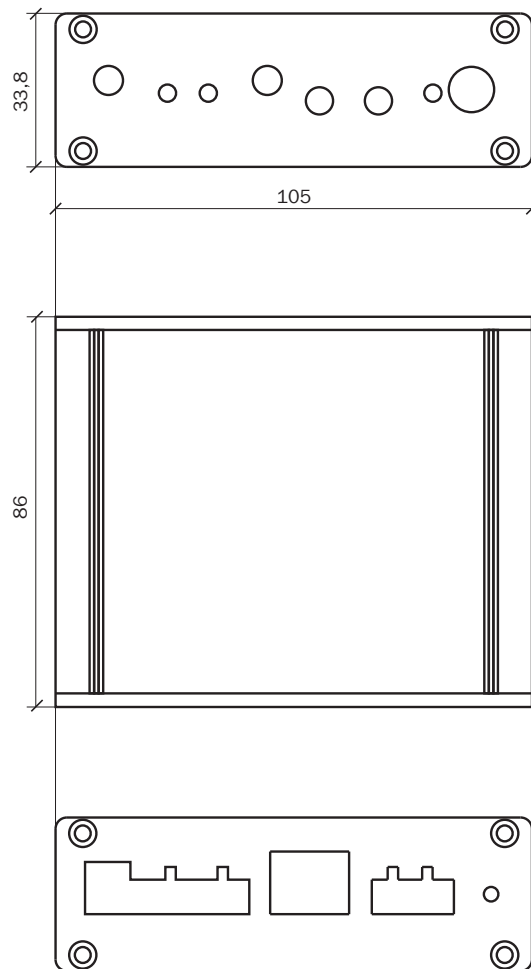

WITH LUGS

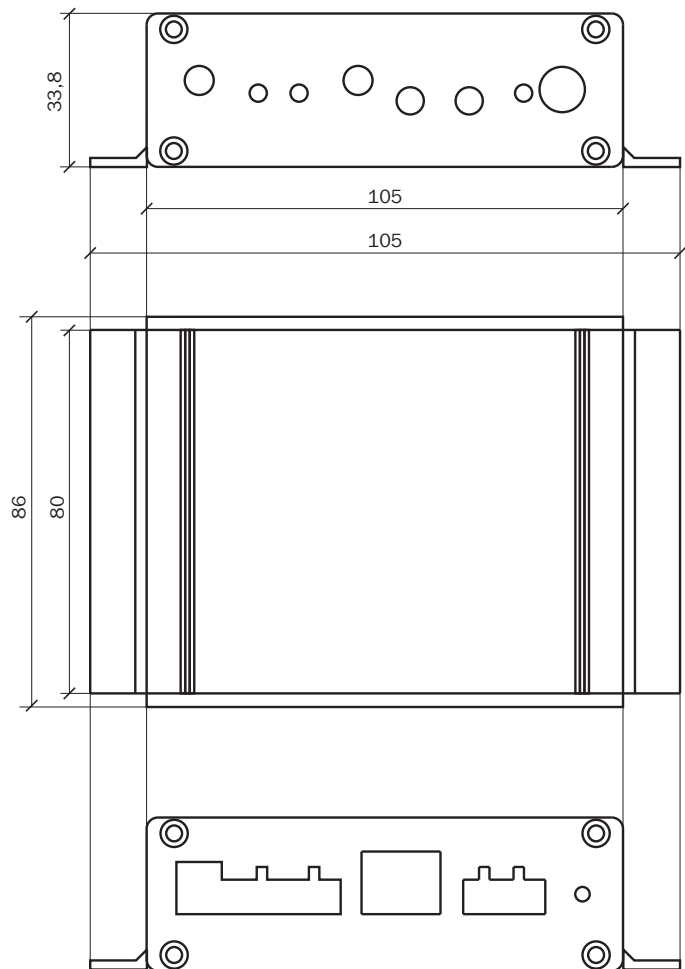

From ideas to implementation

Version: 2.1
Issued: September 2014

2N Telekomunikace, a.s.
Modřanská 621, 143 01 Prague 4
Company ID No 26183960
sales@2n.cz
www.2n.cz

Graphic design: Petr Huml
Typeface: Formata v.o.s.
Illustrations: Michael Petrus
Proofreading: Šimon Antropius

2014 © 2N Telekomunikace, a.s.

The depictions, dimensions, technical data and other parameters in the catalogue are non-binding and can be changed at any time without prior notification in the context of changes to the range and technical innovations. We bear no liability for printing errors. Upon the issue of this catalogue, all previous editions become invalid.



2N TELEKOMUNIKACE a.s.

Modřanská 621, 143 00 Praha 4

Tel.: +420 261 301 400, Fax: +420 261 301 499, E-mail: obchod@2n.cz

International Sales Division

Tel.: +420 261 301 500, Fax: 261 301 599, E-mail: sales@2n.cz