

AIPHONE

IS SERIES

Commercial & Security IP Video Intercom system

Standard (IP) System

OPERATION MANUAL

GETTING STARTED

SETTING AND ADJUSTMENT

USING THE SYSTEM

APPENDIX

Thank you for selecting Aiphone for your communication and security needs. Please read this manual and the separate "SETTING MANUAL" carefully before setting and using this system.

* Please make sure to read this manual for safe and correct use of the system, and keep it in a safe place for future reference.

Please note that images and illustrations depicted in this manual may differ from the actual ones.

CONTENTS

INTRODUCTION.....	4
PRECAUTIONS	4
WARNING	4
CAUTION	4
GENERAL PRECAUTIONS	4
Notes on using this system	5
Notices.....	5

GETTING STARTED 6

PART NAMES..... 6

Color monitor master station	6
■ Control panel	6
■ Monitor	7

Vandal-resistant door station	9
-------------------------------------	---

Room sub station	10
------------------------	----

OUTLINE OF OPERATIONS 11

Communication.....	12
Transferring.....	12
Paging.....	13
Monitoring	13
Door release	14
Communicating and operating the system with telephone (North America only)	14

SETTING AND ADJUSTMENT 15

MASTER STATION SETTINGS AND ADJUSTMENTS..... 15

Setting items	15
Setting the display language	16
Adjusting screen brightness [BRIGHTNESS].....	16
Adjusting sound volume [TONE VOL], [RECEIVE VOL].....	16
Initial settings [INITIAL SETTING].....	17

USING THE SYSTEM..... 21

RECEIVING AND ANSWERING A CALL ON THE MASTER STATION 21

Receiving a call.....	21
-----------------------	----

Answering a call	22
------------------------	----

- Communication in the hands-free mode
- Communication in the press-to-talk mode
- Communication by using the handset ...

Viewing video images at a video door station 24

- Switching Zoom/Wide.....
- Pan & Tilt
- Adjusting images

Transferring to another master station 26

- Communication transferring
- Call transferring

Door release 27

Using the PRIVACY function..... 27

PERFORMING CALLING, MONITORING, PAGING AND CHIME PAGING ON THE MASTER STATION 28

Searching for a station, zone or remote site 28

- Searching for a station, zone or remote site from the list.....
- Searching for a station or zone by number using the dial keys
- Searching for a station, zone or remote site from the placed call or received call list.....
- Selecting a station, zone or remote site by using the speed dial buttons.....

Calling another station (direct voice call)	35
Monitoring	36
■ Monitoring.....	36
■ Scan-monitoring	36
Viewing video images at the target station.....	36
Paging	37
Chime paging	37
OTHER FUNCTIONS	38
Communicating with telephone (North America only)	38
Sending e-mails	39
Other functions (combined with connected external devices).....	39
APPENDIX.....	40
TECHNICAL PRECAUTIONS ...	40
AVAILABLE CHARACTER LIST	40
SPECIFICATIONS	41
WARRANTY.....	44

INTRODUCTION

The IS system is a commercial and security video intercom system especially designed for applications in facilities such as office buildings, factories, schools, hospitals, and prisons. Installed separately from conventional general-purpose internal communications systems, the IS system can be used as a video door entry system, emergency announcement system, rescue assistance system, urgent call system, public announcement system, and access control system.

PRECAUTIONS

- ⊘ General Prohibitions
- ⊘ Prohibition to Dismantle the Unit
- ⊘ Prohibition on Subjecting the Unit to Water
- ⚠ General Precautions

⚠ WARNING

Negligence could result in death or serious injury.

- ⊘ 1. Do not dismantle or alter the unit. Fire or electric shock could result.
- ⊘ 2. Keep the unit away from water or any other liquid. Fire or electric shock could result.
- ⊘ 3. High voltage is present internally. Do not open the case. Electric shock could result.
- ⊘ 4. Do not connect any non-specified power source to the +, - terminals. Also, do not install two power supplies in parallel to a single input. Fire or damage to the unit could result.
- ⊘ 5. Do not connect any terminal on the unit to an AC power line. Fire or electric shock could result.
- ⊘ 6. Do not use power supply with a voltage other than specified. Fire or electric shock could result.
- ⊘ 7. Do not put any metal or flammable material into the unit through the openings. Fire, electric shock, or unit trouble could result.
- ⊘ 8. The unit is not explosion-proof. Do not install or use near gases or flammable materials. Fire or explosion could result.
- ⚠ 9. Existing wiring such as chime wiring, etc. may contain high voltage AC electricity. Damage to the unit or electric shock could result. Wiring and installation should be done by a qualified technician.

⚠ CAUTION

Negligence could result in injury to people or damage to property.

- ⊘ 1. Do not install or make any wire terminations while power supply is plugged in. It can cause electrical shock or damage to the unit.
- ⚠ 2. When mounting the unit on a wall, install the unit in a convenient location, but not where it could be jarred or bumped. Injury could result.
- ⚠ 3. Before turning on power, make sure wires are not crossed or shorted. If not, fire or electric shock could result.
- ⚠ 4. For power supply, use Aiphone power supply model or model specified for use with system. If non-specified product is used, fire or malfunction could result.
- ⚠ 5. On products with ground terminals, connect to an earth ground. Fire or malfunction could result.
- ⊘ 6. Do not put anything on the unit or cover the unit with cloth, etc. Fire or unit trouble could result.

- ⊘ 7. Do not install the unit in any of the following locations. Fire, electric shock, or unit trouble could result.
 - * Places under direct sunlight or places near heating equipment that varies in temperature.
 - * Places subject to dust, oil, chemicals, hydrogen sulfide (hot spring).
 - * Places subject to moisture and humidity extremes, such as bathrooms, cellars, greenhouses, etc.
 - * Places where the temperature is quite low, such as inside a refrigerated area or in front of an air conditioner.
 - * Places subject to steam or smoke (near heating or cooking surfaces).
 - * Where noise generating devices such as dimmer switches or inverter electrical appliances are closeby.
 - * Locations subject to frequent vibration or impact.
- ⊘ 8. Do not put high pressure on the LCD. If fractured, injury could result.
- ⊘ 9. If the LCD is punctured, do not allow contact with the liquid crystal inside. Inflammation could result. If necessary, gargle your mouth and clean your eyes or skin with clear water for at least 15 minutes, and consult your doctor.
- ⚠ 10. Do not use the handset when you perform a call test or check the chime volume, otherwise it may cause damage to your ear. Be sure to use the built-in speaker.
- ⚠ 11. Be sure to perform a call test or check the chime volume with the handset on the hook. If you operate the hook switch with the handset on your ear, a sudden call etc. may arrive causing damage to your ear.

GENERAL PRECAUTIONS

- 1. Keep the unit more than 1m (3.3') away from radio or TV set.
- 2. Keep the intercom wires more than 30cm (12") away from AC 100-240V wiring. AC induced noise and/or unit malfunction could result.
- 3. Install the unit in an area that will be accessible for future inspections, repairs, and maintenance.
- 4. As to other manufacturer's devices (such as sensor, detectors, door releases) used with this system, comply with the Specifications and Warranty conditions that the manufacturers or vendors present.
- 5. If the unit is down or does not operate properly, unplug the power supply or turn off the POWER switches.
- 6. When wall-mounted, the top of the unit may darken and sooty. This does not indicate a malfunction.
- 7. The unit case may become a warm with use, but this is not a unit malfunction.
- 8. If it is used close to a cellular phone, the unit may malfunction.
- 9. The unit can be damaged if dropped. Handle with care.

10. The unit becomes inoperative during power failure.
11. In areas where broadcasting station antennas are close by, the intercom system may be affected by radio frequency interference.
12. All the units, except for door station, is designed for indoor use only. Do not use outdoors.
13. This product, being a control unit of door release, should not be used as a crime prevention device.
14. It must be noted in advance that the LCD panel, though manufactured with very high precision techniques, inevitably will have a very small portion of its picture elements always lit or not lit at all. This is not considered a unit malfunction.
15. Door station is weather-resistant, but do not spray high-pressure water. Unit trouble could result.
16. Due to the environmental sound around the unit, it may hinder smooth communication, but this is not a malfunction.
17. Refrain from using the color monitor station in sunlit areas.
18. At night, due to reduced lighting on the object, the monitor sees more noise and the face becomes more difficult to see, but this is not malfunction.
19. For the hands-free communication:
If you stand too far away, it may be difficult for the other person to hear the communication.
20. If there are loud noises around the unit (such as music playing or children crying), the sound may break up and be difficult to hear.
21. During communication, if you speak before the other person has finished talking, your voice may not come through clearly. Communication will proceed smoothly if you wait until the other person has finished before speaking.
22. At a gate or porch illuminated by a fluorescent lamp, the picture may vary, but this is not a malfunction.
23. The outline of video images displayed by video door station may differ from that of the actual person(s) or background, but this is not a malfunction.
24. If the surface of a video door station freezes during wintertime, the picture may become difficult to see or the call button (including the call button of audio door station) may not move, but this is not a malfunction.
25. Aiphone assumes no responsibility for corruption of saved information (such as changes to or deletion of saved information). Please be aware of this in advance.
26. Warm-color lighting shining on the video door station may change the tint of the picture on the monitor.
27. When outside temperature lowers sharply after rainfall, etc., the inside of the camera may fog up slightly, causing a blurry picture, but this is not a malfunction. Normal operation will be restored when moisture evaporates.
28. When talking continuously, the talking may be interrupted by the noise cut function because the continuous talk is regarded as a noise, but this is not a malfunction.
29. During monitoring, the noise cut function does not work for making outside sounds easy to hear, so the noise may be heard louder than during communication.
30. When the unit's screen is illuminated with strong light, the image looks white or silhouetted. But this is not a unit trouble.

Notes on using this system

- Depending on the network environment and computer, it may not be useable.
- You need to set the ID/password to access the web server when changing the system settings or doing the system maintenance. The system administrator must keep the ID/password without fail. If you forget the ID/password, you must initialize the unit, thus all the setting contents return to default.
- The ID/Password to access the web server for setting the system is the customer's responsibility. Make sure you set a password that cannot be easily guessed by a third party. We recommend that you change the ID/Password on a regular basis.
- You may not be able to operate stations while updating the System settings by using a PC.
- If communications are congested or multiple video door stations are used for call or communication within the system, the frame rate may be degraded or communications may be interrupted.
- You can also refer to our website at <http://www.aiphone.net/> for some parts of the instructions for this system. (Our website does not support IPv6.)
- **If you are experiencing difficulties in the use of the system, please check our website at <http://www.aiphone.net/>.** (Our website does not support IPv6.)

Notices

- We will under no conditions be liable for damage that occurs due to failures in network equipment; failures due to internet providers and cell phone companies; failures such as disconnected lines and other losses in communication, which render it impossible to provide this service or in any way delay this service due to causes outside of our responsibility; or if an error or missing data occurs during transmission.
- We will under no conditions be liable for damage caused if a customer's password or transmitted information are leaked through bugging or unlawful computer access over Internet communication.
- We will under no conditions be liable for damage that occurs due to the inability to communicate due to malfunctions, problems, or operational errors in this product.
- We will under no conditions be liable for any damages or losses resulting from this product's contents or specifications.
- This manual was created by Aiphone Co., Ltd., all rights reserved. Copying a part of or this entire manual without prior permission from Aiphone Co., Ltd. is strictly forbidden.
- Please note that images and illustrations depicted in this manual may differ from the actual ones.
- Please note that this manual may be revised or changed without prior notice.
- Please note that product specifications may be changed for the sake of improvement without prior notice.
- Please be aware that it is the customer's responsibility to ensure that their computer is secure. We will under no conditions be liable for security failures.
- This system is not intended for life support or crime prevention. It is just a supplementary means of conveying information. Aiphone will under no conditions be liable for loss of life or property which occurs while the system is being operated.
- This system is not intended for preventing physical injury, accidents caused by disasters and property damage.
- When the web server is rebooted, all the registrations are returned to the settings that were made last time. Please make the settings again.

GETTING STARTED

PART NAMES

Color monitor master station

Color monitor master station (IS-MV)

Color monitor IP master station (IS-IPMV)

■ Control panel

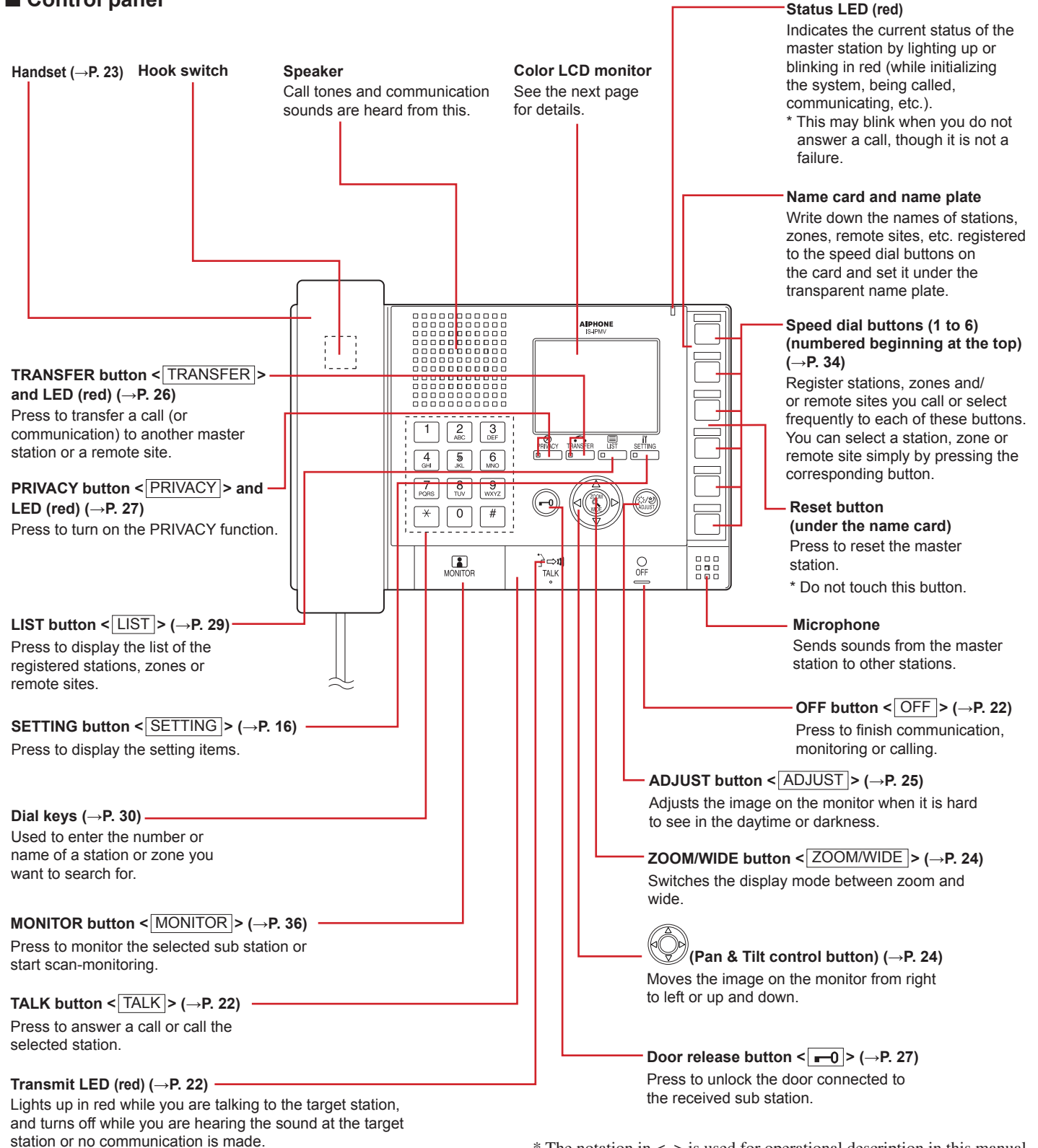

* The notation in < > is used for operational description in this manual.

■ Monitor

Display item examples

List of stations, zones and/or remote sites (→P. 30)

The list of the stations, zones and/or remote sites you searched for is shown here. Stations, zones and/or remote sites are displayed either by number and/or name depending on the setting on the "INITIAL SETTING".

* "NOT AVAILABLE" appears in the list when a corresponding station, zone or remote site is not detected.

List page no. (→P. 17)

When the list of stations, zones and/or remote sites, or setting items consists of two or more pages, the current page no. is shown here.

Information display (→"USING THE SYSTEM")

Displays the name (or number) of selected or calling station, operation method, etc.

Status display icons

The following icons are displayed here depending on the status of the master station.

* The color of an icon changes according to the priority level.

Normal: green

Priority: yellow

Urgent: red

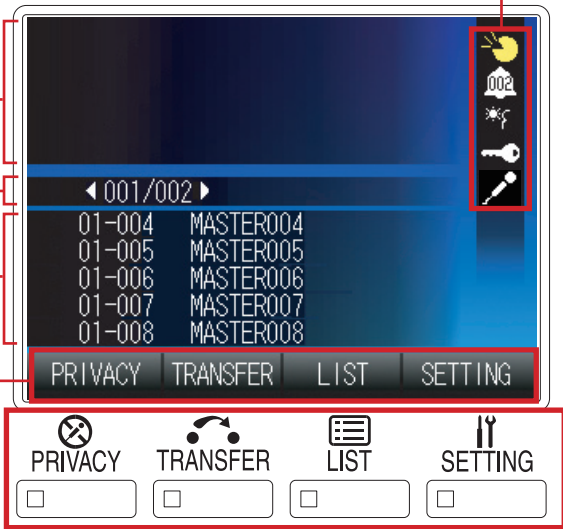

Function buttons

The function buttons are also enabled when the function indicators just above the buttons are displayed.

* The function name on an indicator may differ from the name of the corresponding button. In that case, the button operates as the function of the indicator.

Function indicators

The indicators differ depending on the display mode.

* These are not touch panel keys.

Icons	The status when the icon appears
	Appears while talking to the target station, being called from another master station, etc.
	Appears while being called.
	Appears while being called from two or more sub stations. (For example, "002" on the figure shows that 2 calls are coming in at the same time.) * There is a case that "001" appears on the icon when being called from a station while talking to another. * This icon will not be displayed on an IP master station (IS-IPMV).
	Appears when paging.
	Appears when the image on the monitor is adjusted by pressing the [ADJUST] button.
	Appears while the door release is activated by pressing the door release button.
	Appears when the microphone volume is set to OFF, or the PRIVACY function is activated.
	Appears while transferring is suspended.
	Appears while receiving a call from a station transferred by another one. * This icon also appears on the station that performs transferring.
	Appears while searching for a station, zone or remote site.
	Appears while monitoring.
	Appears during scan-monitoring.
	Appears when an error message is displayed.
	Appears when a setting screen is displayed.
	Appears while performing chime paging.
	Appears when the microphone volume is set to ON.
	Shows it is a waiting time for shifting to the next performance, etc.

NOTE:

The above display example differs from the actual one.

Display examples

[Standby mode]

* The monitor with no display (black) may also be in the standby mode.

Date, time, station no. and name of this master station

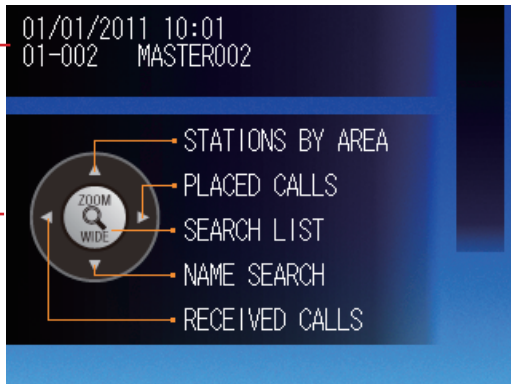

Key map for selecting the search items

[When talking with a door station]

Station no. and name (or remote site no. and name) of the target station or calling station

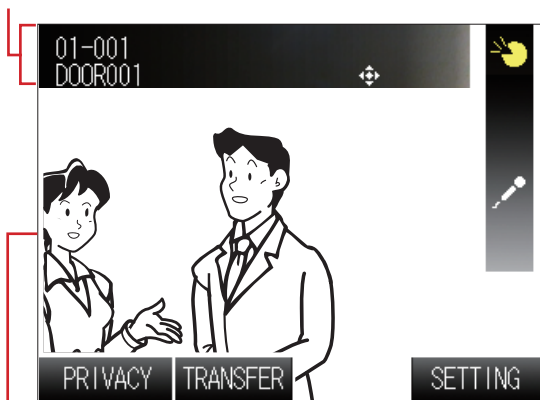

If the target station or calling station is a video door station, the video image at the station is displayed.

[When called from a room sub station]

Station no. and name (or remote site no. and name) of the calling station

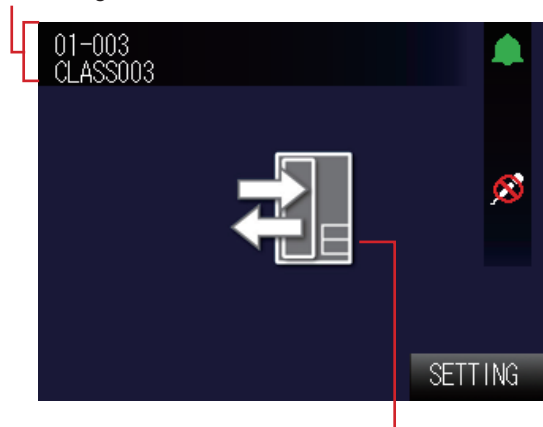

The calling station type image (or remote site symbol image)

If the target station or calling station is an audio door station, room sub station or master station, no video image is displayed.

Displaying call and/or (chime) paging record and reception record

Call and/or (chime) paging record and reception record can be displayed on the monitor for each up to 20 items.

* When no answer was returned to an incoming call from this master station, it is displayed in the reception record list. In the records, unanswered incoming calls are marked with ☆ (outlined in yellow) or ★.

- ★ : Unanswered calls that have not been confirmed on the list yet
- ☆ : Unanswered calls that have already been confirmed on the list

NOTES:

- The calls that are not received at the master station are not recorded. (An IS-IPMV cannot receive two or more calls at a time.)
- The record of unanswered incoming calls can also be automatically displayed by the setting on the "INITIAL SETTING". (→ P. 18)
- The reception of chime is not recorded.
- A monitoring operation is not recorded. If monitoring is shifted to talking, it will be recorded.

Vandal-resistant door station

Vandal-resistant video door station (IS-DV) IP vandal-resistant video door station (IS-IPDV) (surface-mount)

White light LED

Lights up automatically when a call operation is made on this unit at night.

Name plate (with backlight)

Write down a name on the plate. The backlight is always lit while the power is on to make a visitor confirm the name even at night.

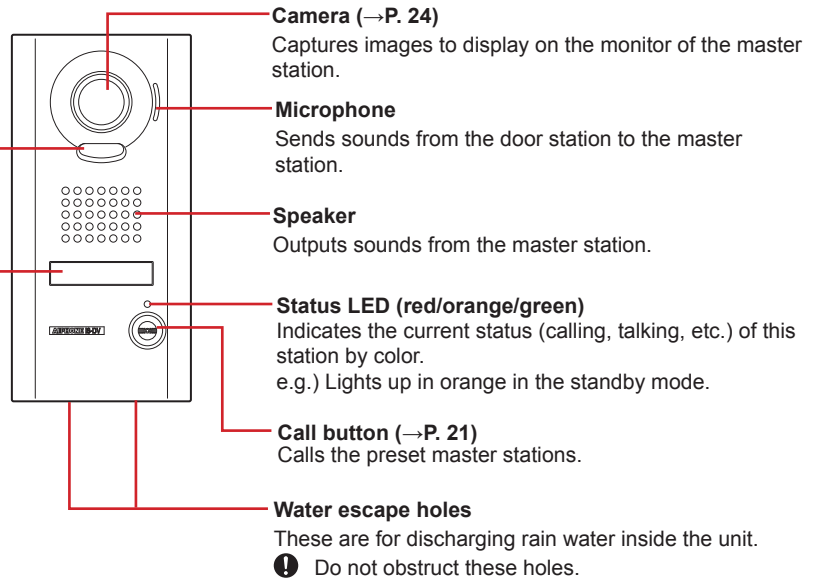

Vandal-resistant video door station (IS-DVF) IP vandal-resistant video door station (IS-IPDVF) (flush-mount)

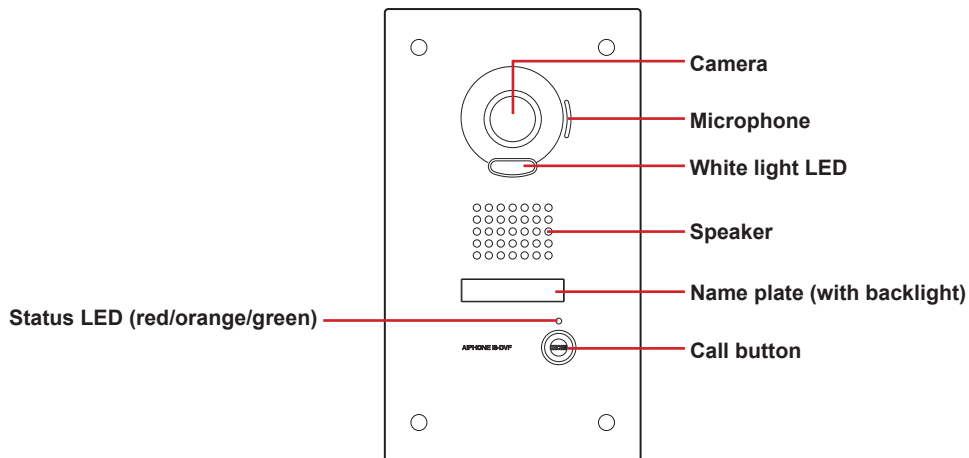

Vandal-resistant audio door station (flush-mount) (IS-SS, IS-SS-2G)

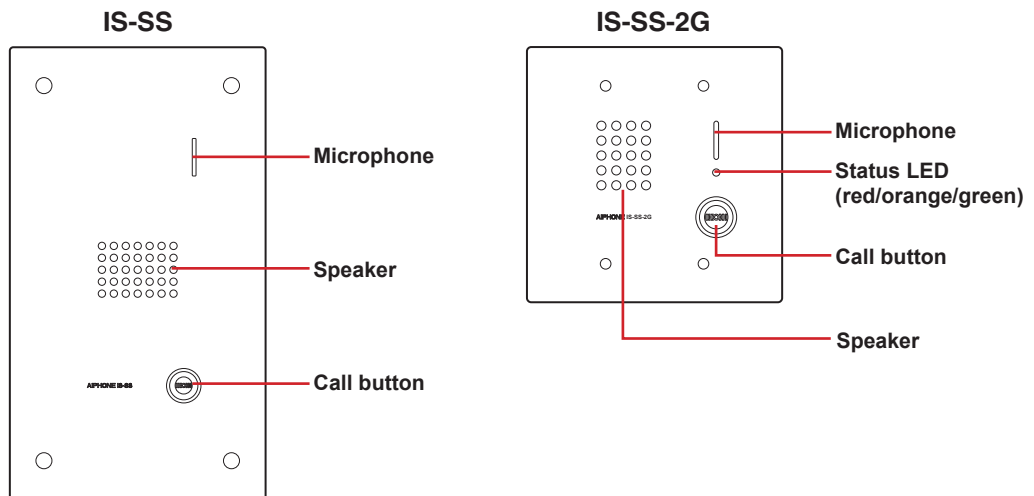

Room sub station

Room sub station (IS-RS)

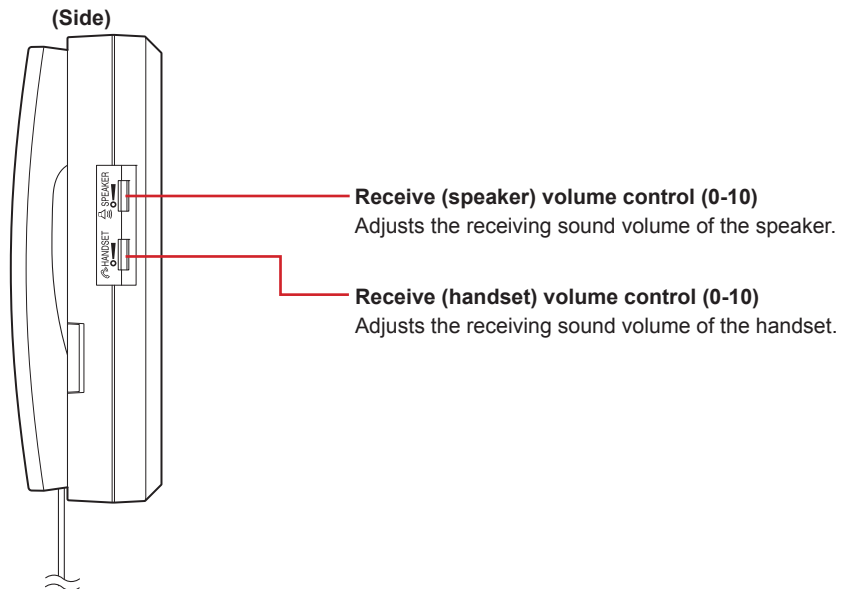
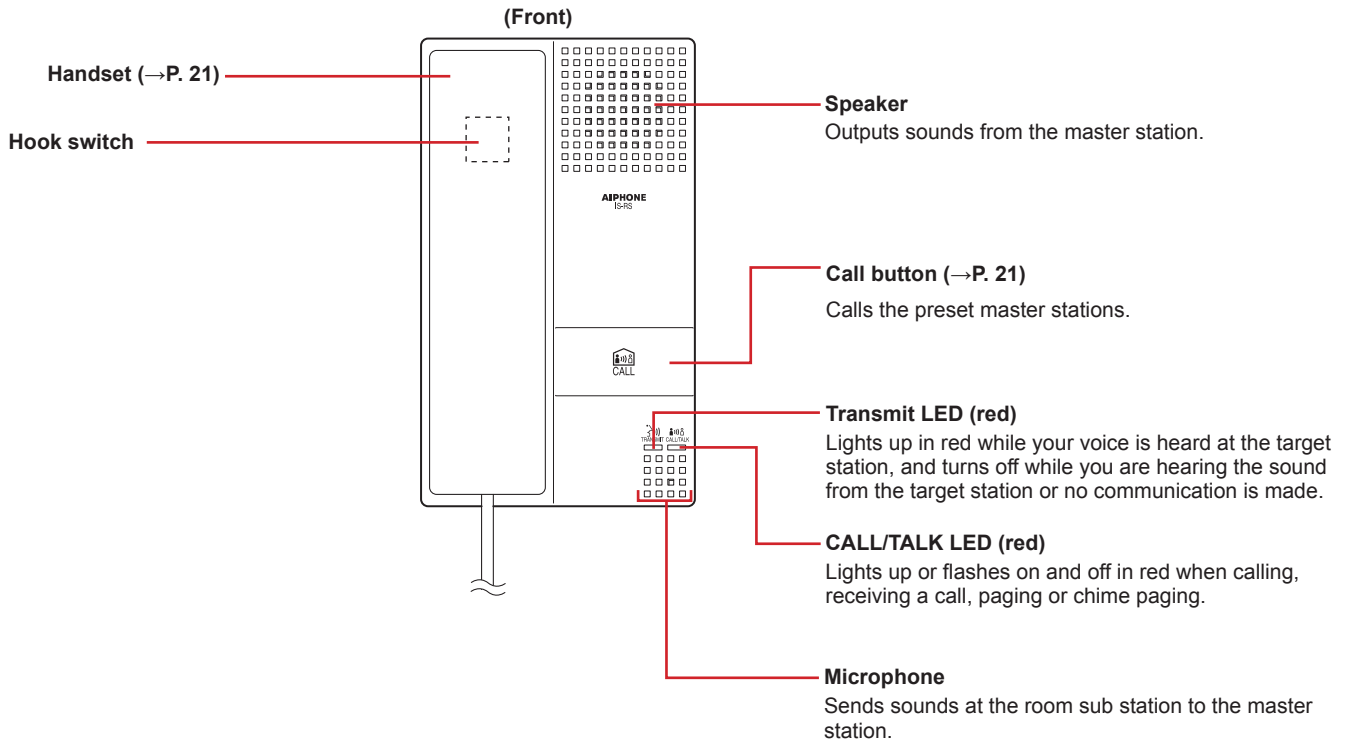

OUTLINE OF OPERATIONS

This manual mainly describes the following operations.

- Operations you can do within a site (communication, transferring, paging, monitoring, door release, etc.)
- Operations you can do between sites (communication, transferring, paging, door release, etc.)
- Telephone operations and other telephone-related operations (North America only)

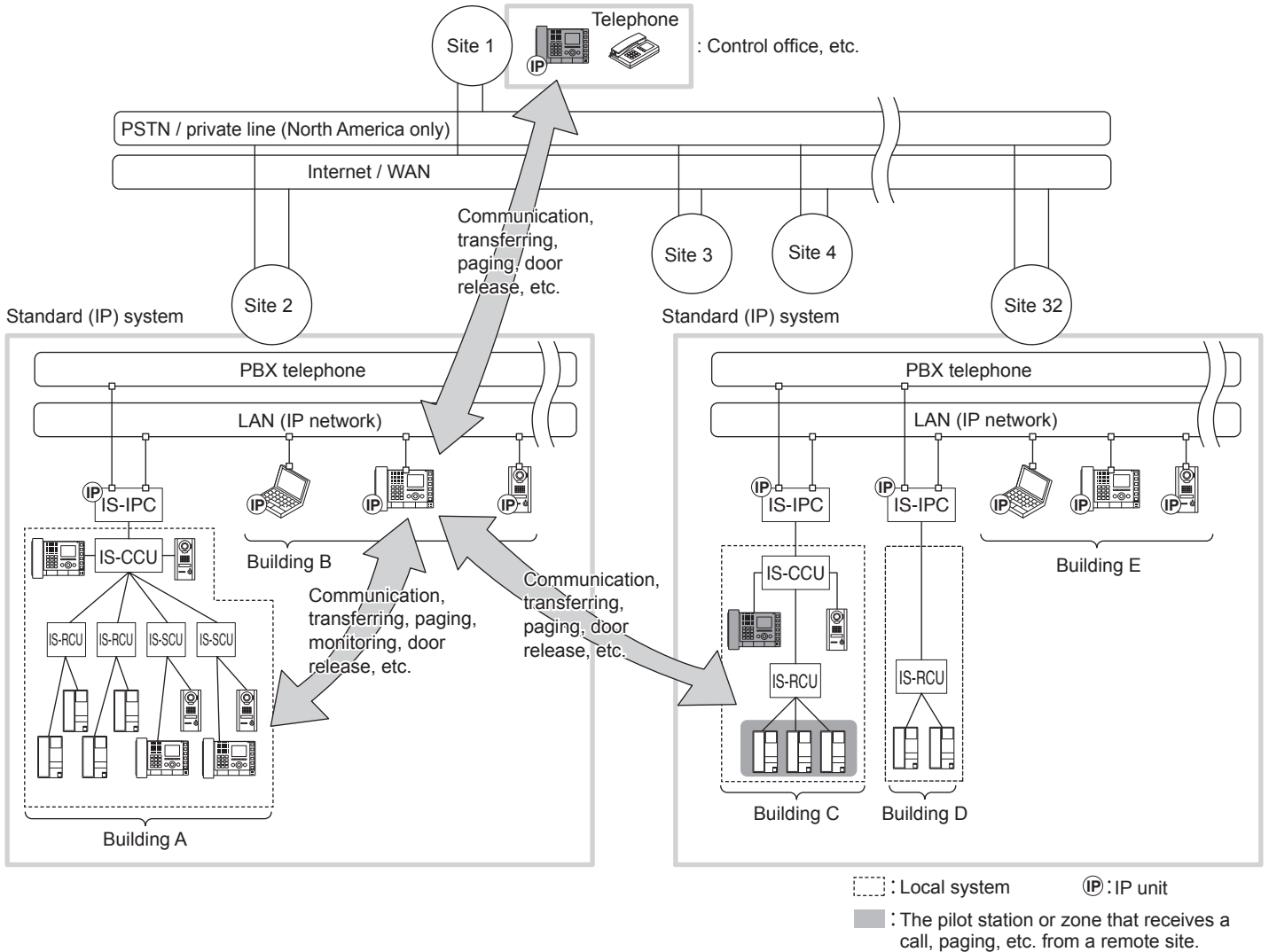

NOTES:

- The arrows in the figure above show examples of operations.
- For the available functions and operations in a local system, refer to the “OPERATION MANUAL” for the local system.
- For operating a PC master station (IS-SOFT), refer to the “OPERATION MANUAL” for the PC master station.
- You can communicate with the pilot station or page the pilot zone registered in a remote site. You cannot select a desired station or zone in a remote site.
- Depending on the system configuration of a remote site, some operations to the site may be disabled.
- A call or talk may not be possible when the communication path is fully occupied.
- Video images at the target video door station may not appear on the monitor when the video path is fully occupied even though a call or talk is possible.

Communication

- On a sub station (door station or room sub station), you can call up to 20 preset master stations in your site at the same time. Or you can call up to 19 master stations in your site and a remote site (up to 20 master stations at the remote site).
 - On a master station (IS-MV), you can select a call from the list of incoming calls and answer it.
 - On a master station, the communication method can be selected from the hands-free mode, the press-to-talk mode, or using the handset.
- (→P. 22)
- You can also communicate with a remote site (the pilot station registered in the site).

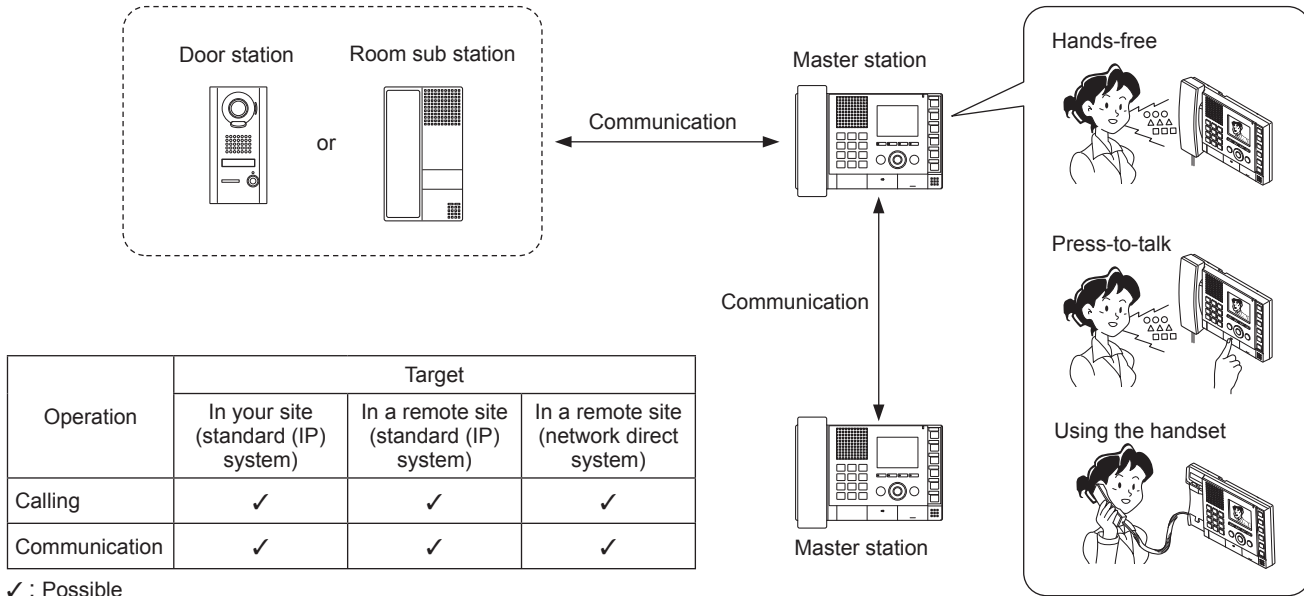

Transferring

When communicating with a received call on a master station, you can transfer it to another master station in your site. (→P. 26)

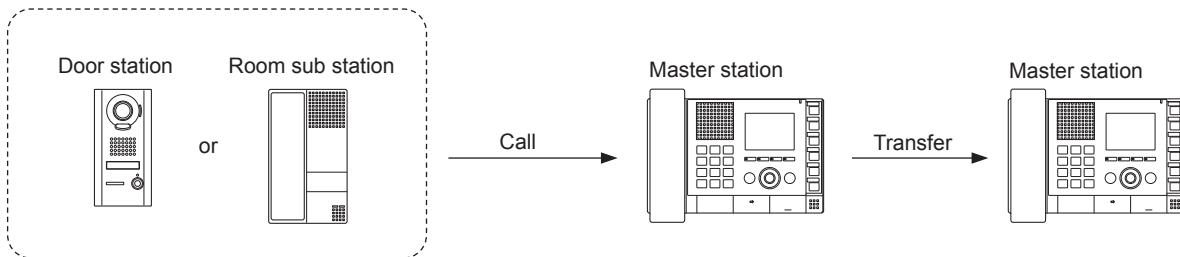

- * You can also make a transfer setting for transferring calls to a designated master station automatically.
- * For a call from another master station, you can transfer it when you are communicating with it (not to the remote site).
- * You can also transfer a call to a remote site. (However, you cannot transfer a call received from a remote site to another remote site.)
- * You cannot transfer a communication to a remote site.

Operation	Target		
	In your site (standard (IP) system)	In a remote site (standard (IP) system)	In a remote site (network direct system)
Communication transferring	✓	—	—
Call transferring (automatic)	✓	✓	✓
Scheduled call transferring (automatic)	✓	✓	✓

✓ : Possible — : Impossible

Paging

On a master station, you can initiate paging or chime paging to the selected zone(s). All the stations previously registered to the zone(s) receive the paging or chime. (→P. 37)

- * You can also call another master station or a sub station in your site individually by direct voice call. The receiver can reply in the hands-free mode.
- * You can also make paging or chime paging to the registered external speaker(s).
- * You can also make paging to the pilot zone in a remote site, or chime paging to the pilot zone in a remote site when the site has chime sources. (The chime paging does not commence when the site does not have a central control unit.)

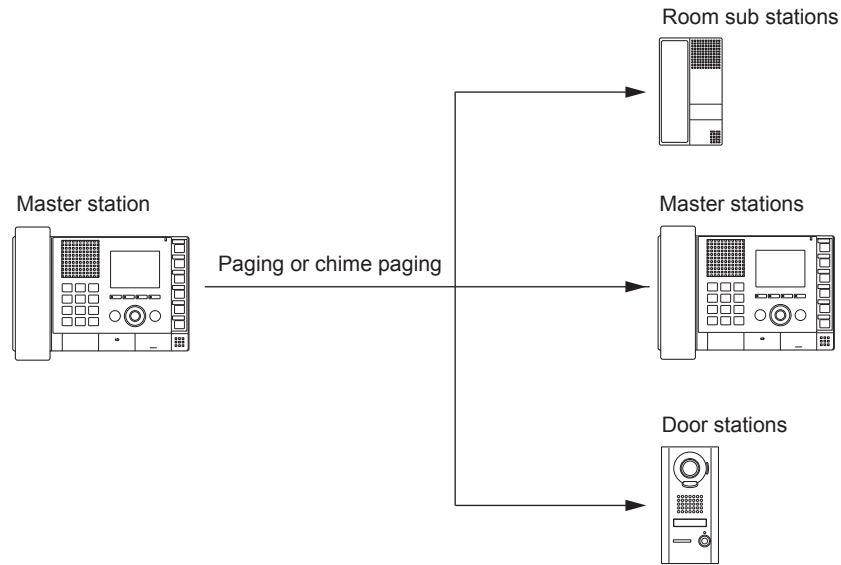

Operation	Target		
	In your site (standard (IP) system)	In a remote site (standard (IP) system)	In a remote site (network direct system)
Paging	✓	✓	✓
Chime paging	✓	✓	—
Scheduled chime paging (automatic)	✓	—	—

✓ : Possible — : Impossible

Monitoring

On a master station, you can monitor a sub station in your site.
You can also initiate the scan-monitoring (monitoring multiple preset stations sequentially).
For an audio door station or room sub station, you can monitor sounds only.
(→P. 36)

- * You cannot monitor or scan-monitor a remote site.

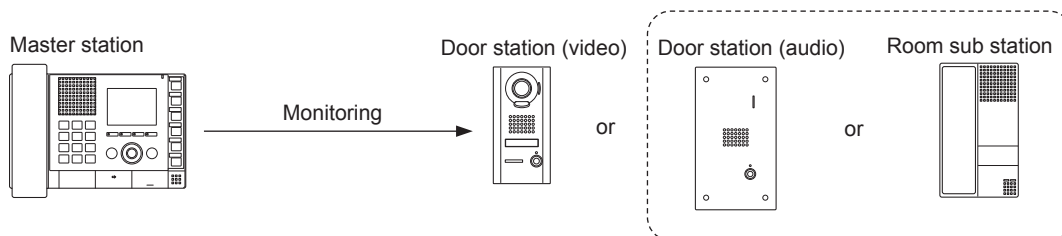

Operation	Target		
	In your site (standard (IP) system)	In a remote site (standard (IP) system)	In a remote site (network direct system)
Monitoring	✓	—	—
Scan-monitoring	✓	—	—

✓ : Possible — : Impossible

Door release

On a master station, you can unlock the door associated with a sub station call in which a door release device is connected. (→P. 27)

* You can also unlock the door (door release device) connected to a sub station in a remote site depending on the setting.

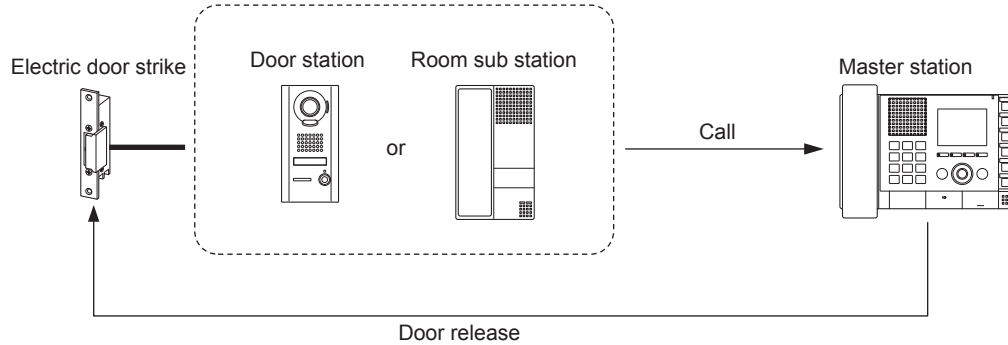

Operation	Target		
	In your site (standard (IP) system)	In a remote site (standard (IP) system)	In a remote site (network direct system)
Door release	✓	✓	✓

✓ : Possible

NOTE:

If the door station does not have a camera, you cannot view the image of the visitor. Confirm the visitor securely.

Communicating and operating the system with telephone (North America only)

The following are possible with telephone:

- Receiving a call transferred from a sub station (other than IS-IPDV and IS-IPDVF)
- Communication
- Door release
- Chime paging

SETTING AND ADJUSTMENT

MASTER STATION SETTINGS AND ADJUSTMENTS

Make the basic and initial settings and adjustments on a master station after the system settings are completed. Make the settings and adjustments to all of the master stations individually.

NOTE: First change the display language for the monitor screen to the language you need. (→ P. 16)

Setting items

You can make the settings and adjustments for the following items. We especially recommend you make all the settings of the items in [INITIAL SETTING] before the first use of the master station.

* [INITIAL SETTING] is available when the master station is in the standby mode.

Item	Sub item	Setting range	Default value	
[BRIGHTNESS]	-	1-10	6	
[TONE VOL]	-	OFF, 1 - 10	6	
[RECEIVE VOL]	-	OFF, 1 - 10	6	
[INITIAL SETTING]	[DOOR CALL TONE]	DOOR CALL: NORMAL	1-6	1
		DOOR CALL: PRIORITY		2
		DOOR CALL: URGENT		3
	[ROOM SUB CALL TONE]	RM SUB CALL: NORMAL	1-6	4
		RM SUB CALL: PRIORITY		5
		RM SUB CALL: URGENT		6
	[COMMUNICATION METHOD]	-	HF (hands-free or press-to-talk) /PTT (press-to-talk)	HF
	[DISPLAY]	[DISPLAY LANGUAGE]	EN (English)	EN
			FR (French)	
			ES (Spanish)	
			NL (Dutch)	
	IT (Italian)			
	DE (German)			
	JP (Japanese)			
	[UN-ANSWERED CALL]	ON/OFF	OFF	
	[LIST ORDER]	ABC/123	123	
	[SPEED DIAL]	[SPEED DIAL1]	(Register a station, zone or remote site to each speed dial.)	-
		[SPEED DIAL2]		
		[SPEED DIAL3]		
[SPEED DIAL4]				
[SPEED DIAL5]				
[SPEED DIAL6]				
[TRANSFER]	[CALL TRANSFER]	ON/OFF	OFF	
	[TRANSFER DESTINA]	(Registering a target)	-	
	[TRANSFER DELAY]	00-60 (sec.)	00	
	[SCHEDULE TRANSFER]	ON/OFF	OFF	
	[SCHEDULE DESTINA]	(Registering a target)	-	
	[TELEPHONE TRANSFER]	ON/OFF	OFF	
	[SCHEDULE TEL TRANSFE]	ON/OFF	OFF	
[PRIVACY]	[PRIVACY MODE]	OFF/1/2	OFF	
	[PRIVACY-2 CALL TONE]	1-6	4	
[INITIALIZATION]	-	NO/YES	NO	

NOTES:

- The monitor will change to the standby mode if approx. one minute has elapsed with no operation on the master station. In that case, the setting results will be saved at that time.
- The above list is a brief overview of the setting items available on the master station. The descriptions, and the style and order of descriptions do not necessarily equate with the actual displays.

Setting the display language

When the master station is started up for the first time, the [DISPLAY LANGUAGE] setting screen appears on the monitor. The display language for the monitor screen is set to English as default. First change it to the language you need as follows.

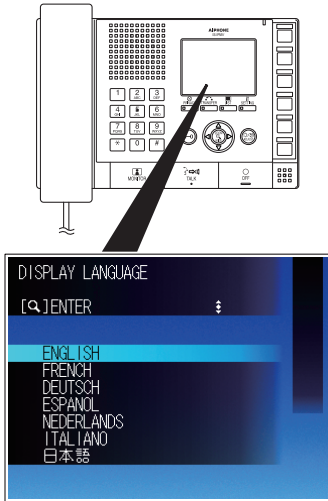

- 1 Press  repeatedly to select the target language (so that it is highlighted).
- 2 Press **ZOOM/WIDE** to decide on the selected one.

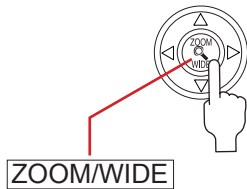

NOTE:

If the [DISPLAY LANGUAGE] setting screen does not appear, press **SETTING**, then select [INITIAL SETTING] → [DISPLAY] → [DISPLAY LANGUAGE], and then select the target language. (→ P. 17-18).

Adjusting screen brightness [BRIGHTNESS]

You can adjust the brightness of the monitor in 10 levels.

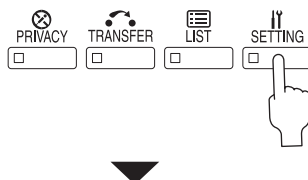

* This adjustment can also be made while receiving a call, communicating or monitoring (when [SETTING] is displayed on the monitor).

- 1 Press **SETTING** in the standby mode.

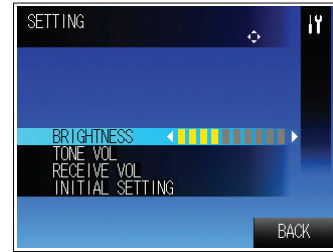

The setting screen appears.



- 2 Press  repeatedly to select [BRIGHTNESS] (so that it is highlighted).
- 3 Press  repeatedly to change the level.
 - * You can see the change of brightness as you change the value.

Adjusting sound volume [TONE VOL], [RECEIVE VOL]

You can adjust the sound volume of call tone [TONE VOL] and receiving tone [RECEIVE VOL] respectively. The adjusting range is off and 1 to 10.

* This adjustment can also be made while receiving a call, communicating or monitoring (when [SETTING] is displayed on the monitor).

- 1 Press **SETTING** in the standby mode. The setting screen appears.

- 2 Press  repeatedly to select [TONE VOL] or [RECEIVE VOL] you wish to adjust (so that it is highlighted).

- 3 Press  repeatedly to change the level.

- * The call tone sounds in the selected level.
- * If you change the level when communicating, you can check the receiving sound volume of the selected level as it's changed.
- * This icon is displayed when the volume is set to off.

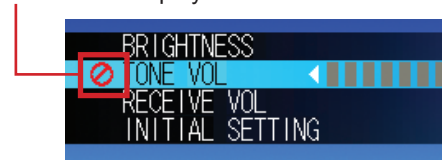

Initial settings [INITIAL SETTING]

Make the initial settings before beginning to use the master station. You can set the following items under [INITIAL SETTING].

001	■ [DOOR CALL TONE]	A
	■ [ROOM SUB CALL TONE]	
	■ [COMMUNICATION METHOD]	B
	■ [DISPLAY]	C
002	■ [SPEED DIAL]	D
	■ [TRANSFER]	E
	■ [INITIALIZATION]	G

Basic setting procedure

- 1) Press **SETTING** in the standby mode.

The setting screen appears.

- 2) Press  repeatedly to select [INITIAL SETTING] (so that it is highlighted).

- 3) Press **ZOOM/WIDE** to select.

- 4) Press  repeatedly to select the item you wish to set (so that it is highlighted).

* Pressing  repeatedly turns pages of the list.

(Page 001/002)

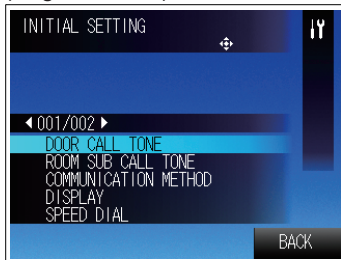

(Page 002/002)

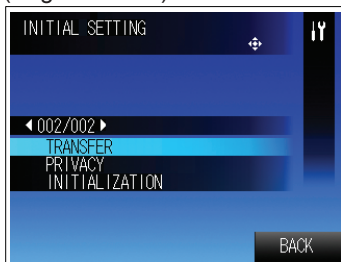

NOTE:

The above display example differs from the actual one.

* When [BACK] is displayed, pressing **SETTING** will return to the setting screen.

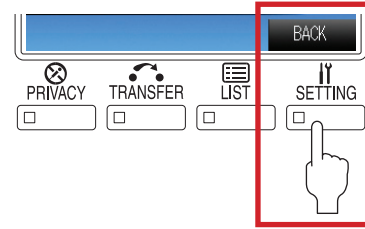

- 5) Press **ZOOM/WIDE** to decide on the selected item.
- 6) Make the settings on the selected item.



(See **A** - **G** below for details on each item.)

(NOTE: Step 1 below corresponds to steps 4) and 5) of "Basic setting procedure" above.)

A Setting the call-in tones [DOOR CALL TONE] and [ROOM SUB CALL TONE]

You can set the call-in tones from door stations [DOOR CALL TONE] and room sub stations [ROOM SUB CALL TONE]. The call-in tones can be set for the priority "Normal", "Priority" and "Urgent" individually.

- 1 Press  repeatedly to select [DOOR CALL TONE] or [ROOM SUB CALL TONE] you wish to set (so that it is highlighted), and then press **ZOOM/WIDE** to decide on the selected item.

- 2 (When setting [DOOR CALL TONE]) :

Press  repeatedly to select [DOOR CALL: NORMAL], [DOOR CALL: PRIORITY] or [DOOR CALL: URGENT] (so that it is highlighted), and then press **ZOOM/WIDE** to decide on the selected one.

- 3 Press  repeatedly to select the desired tone (1 to 6), and then press **ZOOM/WIDE** to decide on the selected one.



* You can check the selected tone by hearing it whenever selected.

- 4 In the same way, set the tone for other priorities, and also for [ROOM SUB CALL TONE].

* Press **SETTING** as "BACK" function to return to the previous screen.

B Setting the communication method for using the microphone and speaker [COMMUNICATION METHOD]

You can select the communication method for using the microphone and speaker between HF (hands-free) and PTT (press-to-talk).

- 1 Press  repeatedly to select [COMMUNICATION METHOD] (so that it is highlighted), and then press **ZOOM/WIDE** to select.
- 2 Press **ZOOM/WIDE**, then press  repeatedly to select [HF] or [PTT] (so that it is highlighted), and then press **ZOOM/WIDE** to decide on the selected one.



[HF]: HF or PTT

[PTT]: PTT only

C Setting the display modes of the monitor [DISPLAY]

You can make the following settings for the display modes.

Sub item	Description	Setting range
[DISPLAY LANGUAGE]	Selects the language for displaying the monitor screen.	EN (English)
		FR (French)
		ES (Spanish)
		NL (Dutch)
		IT (Italian)
		DE (German)
		JP (Japanese)
[UN-ANSWERED CALL]	Sets whether or not to display the record of unanswered incoming call(s) automatically.	ON OFF
[LIST ORDER]	Selects either name or no. to sort the list.	ABC (name)
		123 (no.)

- 1 Press  repeatedly to select [DISPLAY] (so that it is highlighted), and then press **ZOOM/WIDE** to select.
The sub items are displayed.
- 2 Press  repeatedly to select the sub item [DISPLAY LANGUAGE], [UN-ANSWERED CALL] or [LIST ORDER] you wish to set (so that it is highlighted), and then press **ZOOM/WIDE** to decide on the selected one.
- 3 Press  repeatedly to select the desired one, and then press **ZOOM/WIDE** to decide on the selected one.
- 4 In the same way, make the settings for the other sub items.

* Press **SETTING** as "BACK" function to return to the previous screen.

D Registering the desired stations, zones and/or remote sites to speed dials [SPEED DIAL]

You can register the stations, zones and/or remote sites you frequently call or select for paging/chime paging to the speed dials. Up to six stations, zones and/or remote sites can be registered to "SPEED DIAL1" - "SPEED DIAL6". The registered stations, zones and/or remote sites can be selected by using the corresponding speed dial buttons.

* Only one station, zone or remote site can be registered to a speed dial.

- 1 Press  repeatedly to select [SPEED DIAL] (so that it is highlighted), and then press **ZOOM/WIDE** to select.

- 2 (When registering a station, zone or remote site to "SPEED DIAL1"):

Press  to select [SPEED DIAL1] (so that it is highlighted), and then press **ZOOM/WIDE** to decide on the selected one.

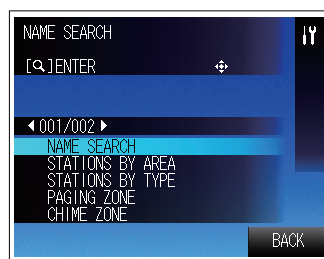

The SEARCH LIST appears.

- 3 Press  to select the desired search item (so that it is highlighted), and then press **ZOOM/WIDE**.
* Refer to pages 29-32 for details about searching for a station, zone or remote site.
- 4 Search for the target station, zone or remote site.
- 5 Press **ZOOM/WIDE** with the selected station, zone or remote site highlighted.
The selected station, zone or remote site is registered to [SPEED DIAL1].
* When a remote site is selected, next select the function ([CALL], [PAGING] or [CHIME]), and then press **ZOOM/WIDE**.
* When registering a chime zone in your site, next select a chime source, and then press **ZOOM/WIDE** again.
- 6 In the same way, register other stations, zones and/or remote sites to [SPEED DIAL2] - [SPEED DIAL6].

NOTE:

To delete the content(s) registered to a speed dial button, select the target speed dial (so that it is highlighted) and then press **PRIVACY** as "DELETE".

E Setting the call transferring [TRANSFER]

You can make the following settings for transferring calls.

Sub item	Description	Setting range
[CALL TRANSFER]	Enables (ON) or disables (OFF) the call transferring.	ON OFF
[TRANSFER DESTINA] (Transfer destination)	(Available when [CALL TRANSFER] is set ON.) Selects a master station in your site or a remote site as the transfer target.	(Registering a master station or a remote site)
[TRANSFER DELAY]	(Available when [CALL TRANSFER] is set ON and the target is set at [TRANSFER DESTINA].) Sets the time of starting transferring after a call is received.	00-60 (sec.)
[SCHEDULE TRANSFER]	Enables or disables the call transferring to be performed on the schedule preset by the system settings automatically.	ON OFF
[SCHEDULE DESTINA] (Schedule destination)	(Available when [SCHEDULE TRANSFER] is set ON.) Selects a master station in your site or a remote site as the transfer target on the schedule.	(Registering a master station or a remote site)
[TELEPHONE TRANSFER]	Enables (ON) or disables (OFF) the automatic call transferring to telephone.	ON OFF
[SCHEDULE TEL TRANSFER] (schedule telephone transfer)	Enables or disables the call transferring to telephone to perform transferring on the schedule preset by the System settings automatically.	ON OFF

- 1 Press  repeatedly to select [TRANSFER] (so that it is highlighted), and then press **ZOOM/WIDE** to select.

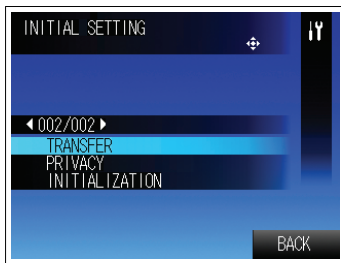

The sub items are displayed.

- * The sub items can also be displayed by pressing **TRANSFER** in the standby mode.

NOTE:

The above display example differs from the actual one.

- 2 Press  repeatedly to select the target sub item (so that it is highlighted), and then press **ZOOM/WIDE** to select.

- 3 Make the settings on each sub item as follows.

[CALL TRANSFER]:

Press  repeatedly to select ON or OFF, and then press **ZOOM/WIDE** to decide on the selected one.

[TRANSFER DESTINA] (Transfer destination):

- * This setting is available only when [CALL TRANSFER] is ON.

Press  repeatedly to select the target master station in your site or a remote site (so that it is highlighted), and then press **ZOOM/WIDE**.

- * The LED on **TRANSFER** lights up (red) when [CALL TRANSFER] is set ON and the target is set at [TRANSFER DESTINA].

[TRANSFER DELAY]:

- * This setting is available only when [CALL TRANSFER] is set ON and the target is set at [TRANSFER DESTINA].

Press  repeatedly to set the delay time, and then press **ZOOM/WIDE** to select.

- * If the delay time is set to "00", a call will be transferred to the target directly.

[SCHEDULE TRANSFER]:

Press  repeatedly to select ON or OFF, and then press **ZOOM/WIDE** to decide on the selected one.

[SCHEDULE DESTINA] (Schedule destination):

- * This setting is available only when [SCHEDULE TRANSFER] is ON.

Press  to select the target master station in your site or a remote site (so that it is highlighted), and then press **ZOOM/WIDE**.

- * Press **SETTING** as "BACK" function to return to the previous screen.

[TELEPHONE TRANSFER]:

Press  repeatedly to select ON or OFF, and then press **ZOOM/WIDE** to decide on the selected one.

* When "ON" is selected, the LED on **TRANSFER** lights up (red).

[SCHEDULE TEL TRANSFER] (Schedule telephone transfer):

Press  repeatedly to select ON or OFF, and then press **ZOOM/WIDE** to decide on the selected one.

F Setting the PRIVACY function [PRIVACY]

Setting of the PRIVACY function is available when called from another master station.

When the PRIVACY MODE is activated, the microphone turns off and you will not be heard by the caller.

Sub item	Description	Setting range
[PRIVACY MODE]	Sets whether or not to activate the PRIVACY function. To activate the PRIVACY function, select the PRIVACY MODE 1 or 2.	(PRIVACY MODE) 1: The microphone is off (mute).
		(PRIVACY MODE) 2: The microphone is off (mute) and the caller and you are notified by a tone when you receive the call that you are in the PRIVACY MODE.
		OFF: The microphone is on.
[PRIVACY-2 CALL TONE]	(Available when (PRIVACY MODE) 2 is selected.) Selects the call tone from 6 types.	1-6

1 Press  repeatedly to select **[PRIVACY]** (so that it is highlighted), and then press **ZOOM/WIDE** to select.

The sub items are displayed.

* The sub items can also be displayed by pressing **PRIVACY** in the standby mode.

2 Press  repeatedly to select the sub item **[PRIVACY MODE]** or **[PRIVACY-2 CALL TONE]** you wish to set (so that it is highlighted), and then press **ZOOM/WIDE** to decide on the selected one.

3 Make the settings on each sub item as follows.



[PRIVACY MODE]:

Press  repeatedly to select the desired mode (so that it is highlighted), and then press **ZOOM/WIDE** to decide on the selected one.

* When (PRIVACY MODE) 1 or (PRIVACY MODE) 2 is selected, the LED on **PRIVACY** lights up (red).

[PRIVACY-2 CALL TONE]:

* This setting is available only when **[PRIVACY MODE]** is set to (PRIVACY MODE) 2.

Press  repeatedly to select the desired call tone, and then press **ZOOM/WIDE** to decide on the selected one.

* You can check the selected tone by hearing it whenever selected.

G Initializing the set contents [INITIALIZATION]

You can reset all the set contents to default.

1 Press  repeatedly to select **[INITIALIZATION]** (so that it is highlighted), and then press **ZOOM/WIDE** to select.

"RETURN TO DEFAULT ?" is displayed.

2 Press **ZOOM/WIDE** to continue the initialization procedure.

3 Press  repeatedly to select **[YES]** (so that it is highlighted) to perform initializing, and then press **ZOOM/WIDE** to select.

* Select **[NO]** if you will cancel initialization.

NOTE:

If you have repositioned the master station, initialize it to clear the speed dial settings etc., and make the settings again.

USING THE SYSTEM

RECEIVING AND ANSWERING A CALL ON THE MASTER STATION

The following describes the communication method using this system.

- * When receiving a call from a remote site, the operation methods are the same as described below, however it may take a longer time for some operations and their responses. For example, there may be a time difference between a call starting at a remote site and the call tone ringing on the target master station in your site.

Receiving a call

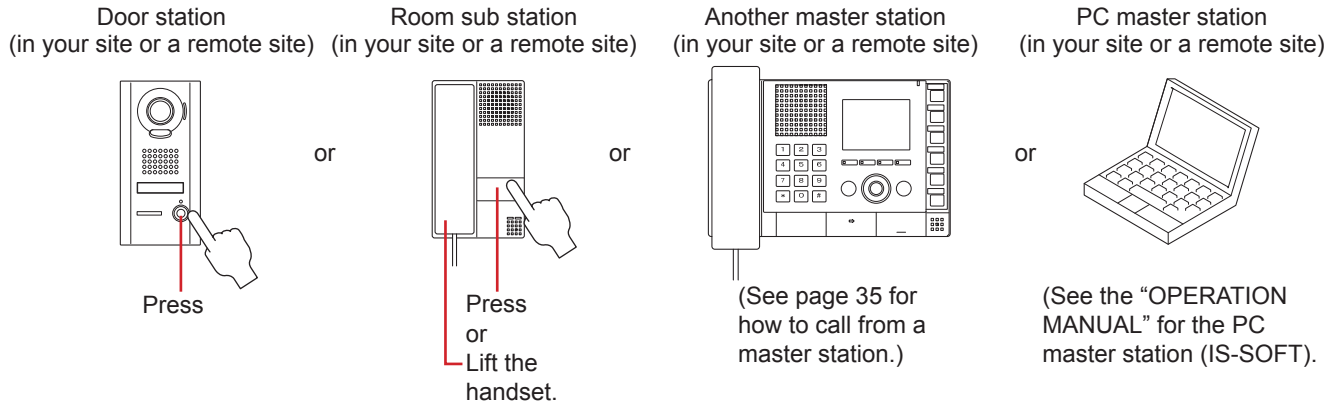

- 1 The call tone rings, and the corresponding display appears.

- * The call tone from a sub station differs from the setting. (→P. 17)

e.g.) When called from a video door station

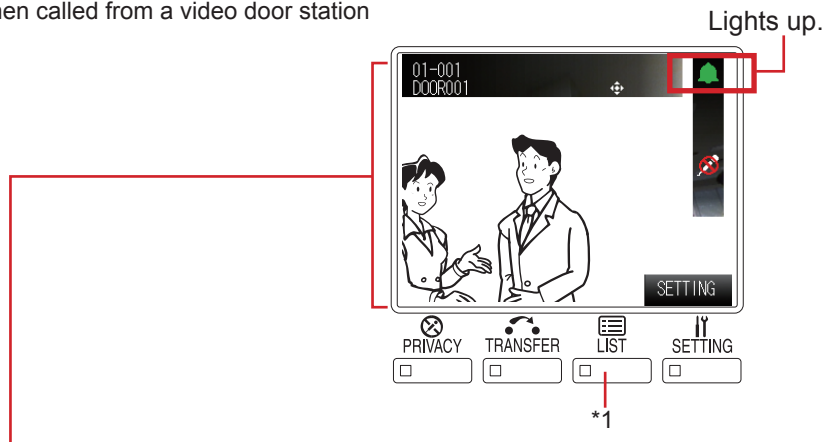

The station no., station name and video image at the calling station (following the symbol image) are displayed. (When called from a remote site, the site no., site name and video image at the calling station (following the symbol image) are displayed. The station name will not be displayed.)

- * It may take long until a video image appears on the monitor.
- * When an audio door station, room sub station or another master station calls in, the station type image is displayed. (The image differs from the calling station type.) When called from a remote site, the remote site symbol image is displayed.
- * An incoming call from another master station will be a direct voice call. (However, when the PRIVACY MODE is set to "2", you will be notified of an incoming call by the display information and call tone.)
- * When you answer a call, the call tone of subsequent incoming calls should be muted until you conclude the first call (except when using IS-IPMV).
- * Depending on the system configuration, it may take a while before talking begins when answering a call with a master station.

*1: LIST

Press to display the list of stations when two or more calls are received. You can select the desired one and start communicating with the caller. (→P. 23)

NOTE:

An IS-IPMV cannot receive two or more calls at a time.

Answering a call

The maximum duration of communication is preset in the System setting. (It can be set to a maximum of 10 minutes.)

- 1 Answer the call in one of the following ways.

■ Communication in the hands-free mode

(Available when "COMMUNICATION METHOD" is set to "HF" in the "INITIAL SETTING")

<When called in from a sub station>

- 1) Press **TALK** momentarily.

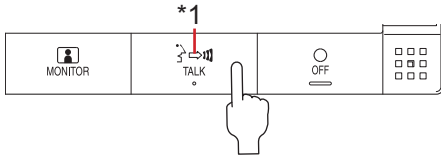

After a beep, you can communicate in the hands-free mode.

*1: When talking: (Lit)
When listening to the caller: (Off)

- 2) When you have finished the communication, press **OFF**.

Communication will end.

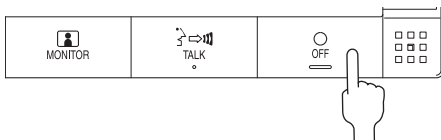

* You can communicate in the press-to-talk mode by the following operation even when "HF" is set (e.g., when it is noisy around you).

- Press and hold **TALK** for a few seconds while being called. (Beeps twice and [PRIVACY] disappears from the display.)
- Press and hold **TALK** for more than one second while communicating. (Beeps once and [PRIVACY] disappears from the display.)

<When you received a direct voice call from another master station>

You can talk back to it. If you press and hold **TALK** for more than one second, it changes to the press-to-talk mode. (Beeps once and [PRIVACY] disappears from the display.)

■ Communication in the press-to-talk mode (Available when "COMMUNICATION METHOD" is set to "PTT" in the "INITIAL SETTING")

<When called in from a sub station>

- 1) Press **TALK** momentarily.

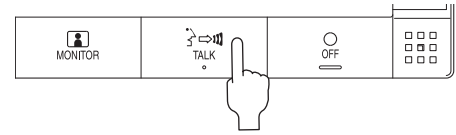

After a beep, you can communicate in the press-to-talk mode.

- 2) Press and hold **TALK** to talk and release to listen to the caller.

(When talking)

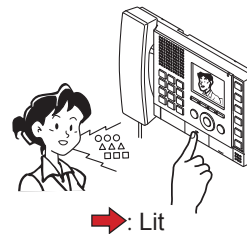

(When listening to the caller)

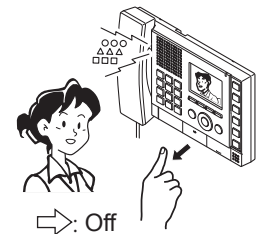

- 3) When you have finished the communication, press **OFF**.

Communication will end.

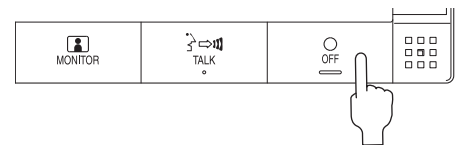

<When you received a direct voice call from another master station>

Press and hold **TALK** to talk with and release to listen to the caller.

■ Communication by using the handset

<In the hands-free mode>

- 1) Lift the handset and you can communicate with the handset.
* You can also communicate in the press-to-talk mode by pressing and holding **TALK**.

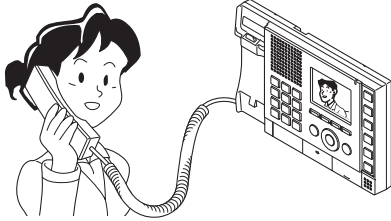

- 2) When you have finished the communication, put the handset on the hook.
Communication will end.

<In the press-to-talk mode>

You can communicate in the press-to-talk mode by pressing and holding **TALK** even when you are communicating with the handset.

NOTE:

Communication will end automatically according to the set communication time.

When two or more calls have arrived (IS-MV)

* An IS-IPMV cannot receive two or more calls at a time.

- 1 Select a call to answer by following the steps 1) and 2) below.

- 1) Press **LIST**.
The list of calling sub stations is displayed.

- 2) Press  repeatedly so that the station no. (and/or name) of the sub station you will select is highlighted.

* Calls from other master stations are not displayed in the list.

- 2 Press **TALK**, **ZOOM/WIDE** or lift the handset^{*1}, and you can answer the call.

- * When the communication is finished, subsequent incoming calls ring.
- * (When you are receiving calls from sub stations):
If you select another sub station while communicating, the current communication is forcibly stopped, and then you can answer the selected station with direct voice call after a beep.

*1: When you are receiving a direct voice call from another master station, lifting the handset will not enable you to communicate with the selected sub station. In that case, press **TALK** or **ZOOM/WIDE** with the handset lifted.

About the priority

The order of priority for two or more actions (communication, calling, paging, monitoring, etc.) performed at the same time is as follows depending on the priority setting.

Priority	Setting	Action
1 (high)	[URGENT], [BROADCAST] ^{*2}	Communication, calling, paging, chime paging.
2	[PRIORITY]	
3	[NORMAL]	
4 (low)	-	Monitoring, scan-monitoring

* Earlier call has priority over later call if the priority setting is the same. When the communication path is occupied, it is notified by a sound.

* Communication takes priority over calling.
However, when a call with higher priority comes in, the communication will be forcibly stopped.

* With an IS-MV, you can select the desired one from the list of currently received calls, etc.

*2: [BROADCAST]:

This can be selected only when you perform paging.
When [BROADCAST] is selected, you can perform paging while interrupting all the other communications of lower priority. In that case, no receiver can answer you.

NOTE:

When communication is stopped by receiving a higher priority operation, a notice sound rings.

Viewing video images at a video door station

You can view video images at the target station when receiving a call from or communicating with a video door station, or monitoring a video door station in your site. The video images can be adjusted as necessary by using the following functions on the master station.

■ Switching Zoom/Wide

The display mode on the monitor can be switched between zoom and wide by each press of **ZOOM/WIDE**.

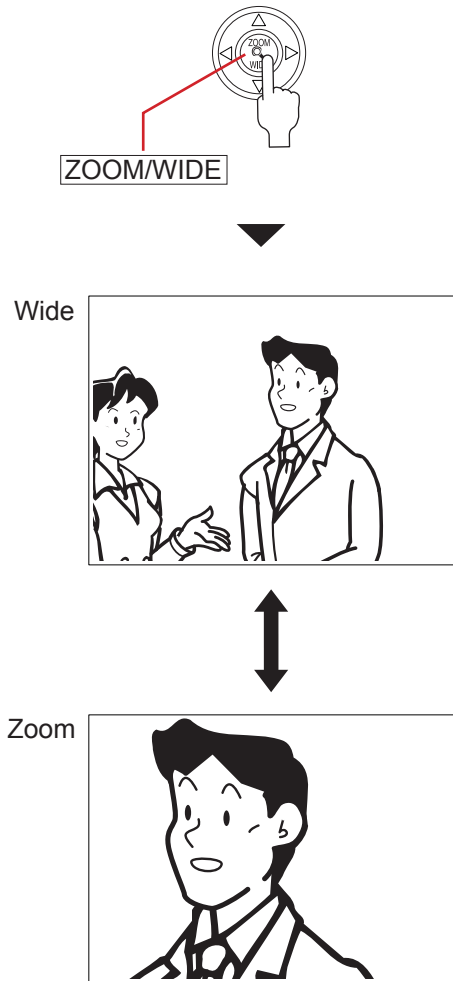

NOTES:

- The preset position of zoom image is set in the System setting on a PC.
- When the display mode switches from wide to zoom, the zoom image from the preset position is displayed.
- Depending on the properties of the video door station camera, the wide image may appear more distorted than the zoom image but this is not a malfunction.
- In the zoom mode, the image can be moved from right to left or up and down.

■ Pan & Tilt

When a zoom image is displayed, pressing  moves the image as shown below.

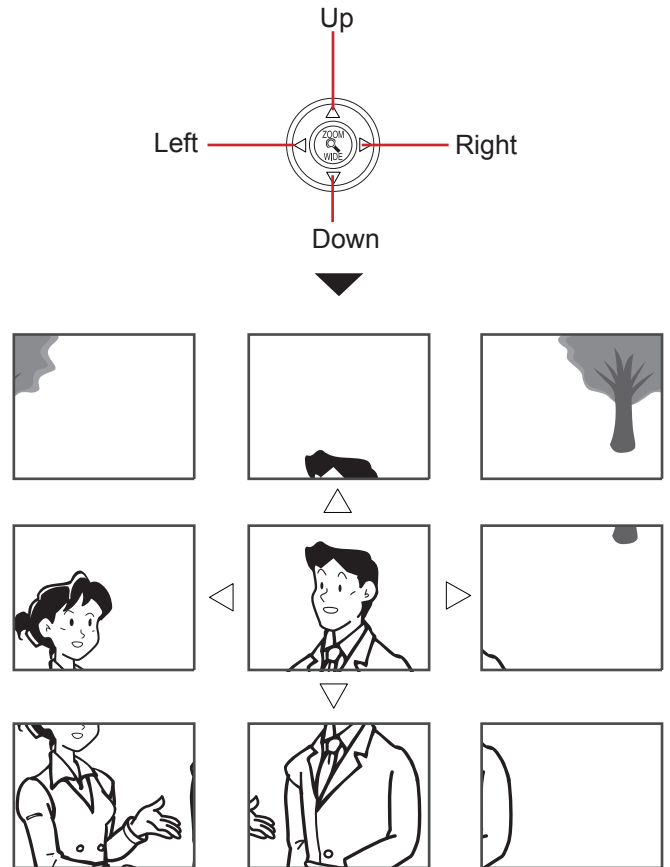

NOTES:

- The image range of the zoom mode and wide mode differs. The edge of wide image will not be displayed with the zoom mode.
- At night, the object image may be blurred and less-visible when moving the image from right to left or up and down because illumination to the object is reduced. The same applies to a moving object.

■ Adjusting images

If the image on the monitor is difficult to see, you can adjust the image.

- 1 Press **ADJUST** when the image is difficult to see.

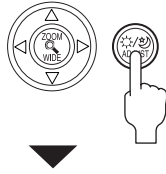

The backlight or night sensitivity is automatically adjusted.

- * The discrimination between day and night is performed automatically by the door station.
- * The adjustment result may vary depending on the System setting on a PC.

<Day>



[Before adjustment]



[After adjustment]

<Night>



[Before adjustment]



[After adjustment]

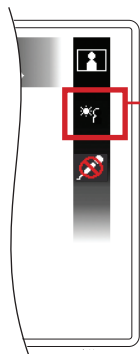

Shows which adjustment is being made.

 : Backlight adjustment

 : Night sensitivity adjustment

To restore the image before adjustment

Press **ADJUST** again.

The icon is cleared and the image before adjustment is restored.

NOTE:

Pressing **ADJUST** at night may make visitors' faces easier to see, but may also make moving objects more difficult to see.

Transferring to another master station

You can transfer a call received from a sub station to another master station while communicating with it (communication transferring), as well as setting calls to be automatically transferred in the "INITIAL SETTING".

- * For a call from another master station, you can transfer it when you are communicating with it. However, you cannot transfer the communication to a remote site.

■ Communication transferring

1 Receive a call and communicate with it. (→P. 21)

2 Press **TRANSFER**.



3 Press **SELECT** to select the master station in your site to which you want to transfer the call (so that it is highlighted) from the list.

4 Press **TALK** or **ZOOM/WIDE**.

Appears while the transfer is being performed.

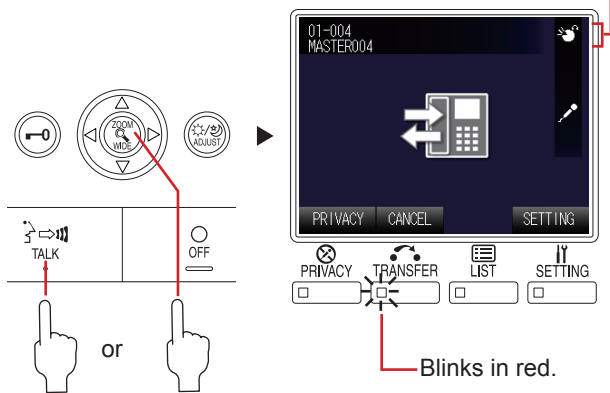

- * While transferring, a sound rings at the source station to indicate a transfer.

5 Press **OFF** to enable the communication between the station that called you and the transfer target station.

NOTE:

You cannot transfer a call from a remote site to another remote site.

■ Call transferring

You can transfer a call to the designated master station (in your site or a remote site) or the telephone registered to the system automatically (without answering it) by the "TRANSFER" settings in the "INITIAL SETTING". (→P. 19)

- * This function is useful when you are absent or you cannot receive and answer a call.
- * When transferring to a remote site, a master station in the remote site should have been registered as the pilot station of the site.

The following settings can be made.

- 1 Transferring a call to the designated master station or remote site automatically (→P. 19 [CALL TRANSFER], [TRANSFER DESTINA])
- 2 Setting the delay time of triggering transferring after a call is received (→P. 19 [TRANSFER DELAY])
- 3 Setting a schedule for call transferring in the System setting on a PC (→P. 19 [SCHEDULE TRANSFER], [SCHEDULE DESTINA])
- 4 Transferring a call to telephone automatically (→P. 20 [TELEPHONE TRANSFER], [SCHEDULE TEL TRANSFE])

- * When both ① and ③ are set, ③ takes priority.

NOTE:

A call from IS-IPDV, IS-IPDVF or a master station cannot be transferred to telephone.

Door release

You can release the door lock while being called from, communicating with, or monitoring a sub station if a door release device is connected to the station.

Press **[0]** while being called from, communicating with, or monitoring the sub station.

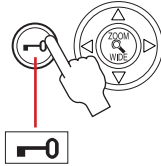

The door lock is released for the time set in the System setting on a PC.

* If the set release time is "0", it can be released while the button is pressed and held.

CAUTION:

Be sure to confirm the visitor securely before releasing the door if the sub station has no camera.

NOTES:

- To enable door release to a door station in a remote site, the appropriate setting must be made at the remote site.
- This function is disabled during scan-monitoring. (→ P. 36)

Using the PRIVACY function

The PRIVACY function of a master station prevents you from being heard by other master stations (in your site) or remote sites that call you.

To activate the PRIVACY function

Set the PRIVACY MODE to "1" or "2" in the "INITIAL SETTING". If you will not use the PRIVACY MODE, set it to "OFF". (→P. 20)

■ While receiving a call

• When the PRIVACY function is activated

The microphone of your master station is muted, so the sounds at your side are not heard by the caller.

• When the PRIVACY function is off

The microphone of your master station is enabled, so the sounds at your side are heard by the caller.

■ To communicate with the caller

• When the PRIVACY function is activated

Press **[TALK]** or lift the handset, and the microphone is enabled. Then you can communicate with the caller.

• When the PRIVACY function is off

You can communicate with the caller without pressing **[TALK]** or lifting the handset.

* To mute the microphone temporarily:

Press and hold **[PRIVACY]**, and the microphone is muted. Release **[PRIVACY]** to enable the microphone.

The status of master station depending on the PRIVACY MODE

PRIVACY MODE	LED	When receiving a call from another master station or remote site	When communicating with a sub station
1	Lit	<ul style="list-style-type: none"> The microphone is muted. When you press [TALK] or lift the handset to answer the call, the microphone is enabled. 	<ul style="list-style-type: none"> Microphone is enabled. The microphone is muted while pressing [PRIVACY].
2	Lit	<ul style="list-style-type: none"> The microphone is muted. When you receive a call from a master station or remote site, the caller and you are notified by a tone that you are in the PRIVACY MODE. When you press [TALK] or lift the handset to answer the call, the microphone is enabled. 	<ul style="list-style-type: none"> Microphone is enabled. The microphone is muted while pressing [PRIVACY].
OFF	Off	<ul style="list-style-type: none"> The microphone is enabled. Communication starts when a direct voice call arrives from a master station in your site or remote site. The microphone is muted while pressing [PRIVACY]. 	<ul style="list-style-type: none"> Microphone is enabled. The microphone is muted while pressing [PRIVACY].

NOTE:

When "COMMUNICATION METHOD" is set to "PTT" (press-to-talk mode) in the "INITIAL SETTING", you do not have to activate the PRIVACY function.

PERFORMING CALLING, MONITORING, PAGING AND CHIME PAGING ON THE MASTER STATION

The following describes how to operate the master station to perform calling, monitoring, paging and chime paging.

* If your standard (IP) system includes a PC master station (IS-SOFT), refer to the "OPERATION MANUAL" for the PC master station (IS-SOFT) for details about operating it.

Searching for a station, zone or remote site

Read this section before you perform calling, monitoring, paging or chime paging for the first time to learn how to search for stations, zones or remote sites. The search can be performed in the following search methods by using the search items, dial keys or speed dial buttons to suit your needs.

Searching for a station, zone or remote site from the list (→P. 30)

Search items: **A**, **B**, **C**, **D**, **E**, **F** (**F** is for a remote site.)

Searching for a station or zone by number using the dial keys (→P. 33)

Searching for a station, zone or remote site from the placed call or received call list (→P. 33)

Search items: **G**, **H**

Selecting a station, zone or remote site by using the speed dial buttons (→P. 34)

Basic procedure for selecting the search items

The search items **A** – **H** can be selected from the standby mode or the SEARCH LIST.

* The items **A** and **B** can be selected from both the standby mode and the SEARCH LIST.

* A remote site can be selected by using the search item **F**, **G**, **H**, or the speeds dial buttons.

[In the standby mode]

Press the corresponding button on  to select the target search item **A**, **B**, **G** or **H** by following the key map.

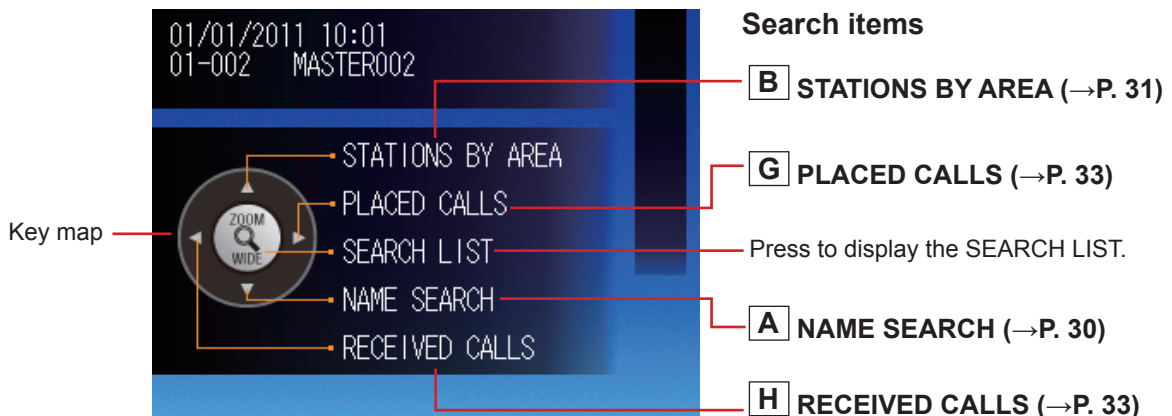
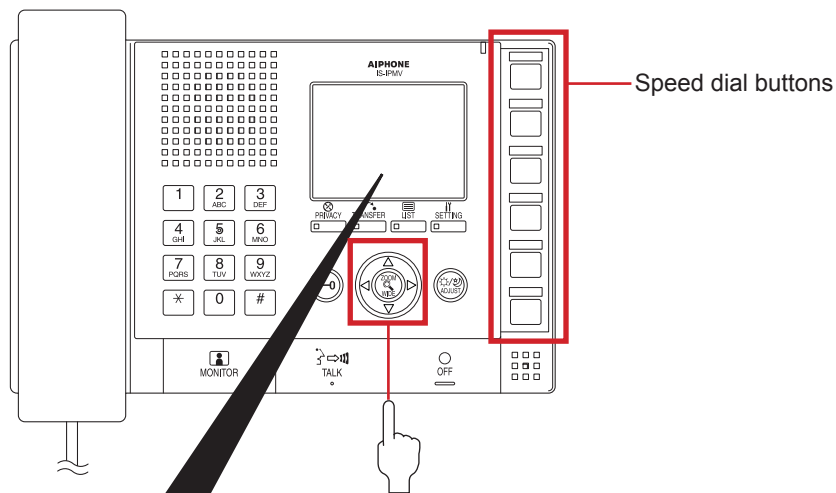

[In the SEARCH LIST]

- 1 Press **LIST** or **ZOOM/WIDE** in the standby mode.
The search items are shown in the SEARCH LIST.

- 2 Press  repeatedly to select the target search item **A** to **F** (so that it is highlighted).

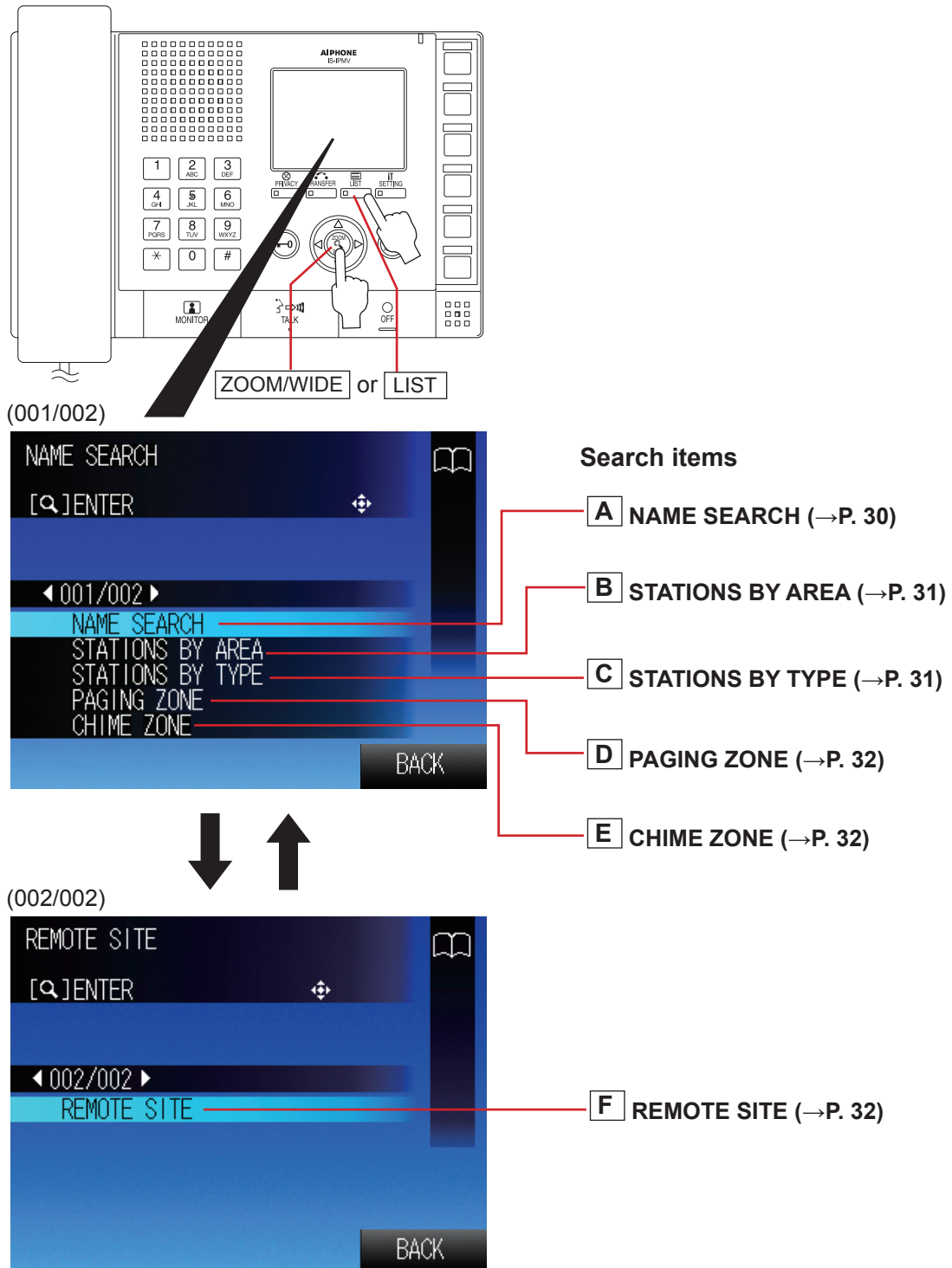

- 3 Press **ZOOM/WIDE** to decide on the selected one.

Searching for a station, zone or remote site from the list

A Searching for a station or zone in your site by entering the name [NAME SEARCH]

- 1 Select [NAME SEARCH] either in the standby mode (→P. 28) or the SEARCH LIST (→P. 29).
- 2 Enter a name by using the dial keys. (→P. 40)

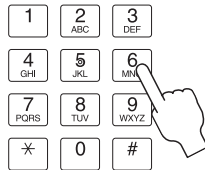

e.g.)

When searching for "MASTER004";
Press the dial keys as follows.

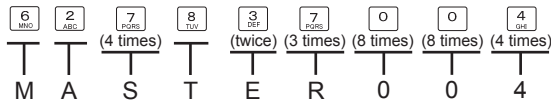

The entered characters are displayed here.

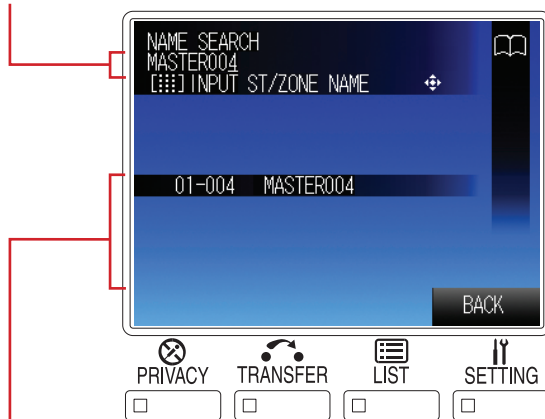

All the station and/or zone names that include the entered characters in your site are displayed in the list.

* The search is narrowed down whenever a character is added.

NOTE:

You can also select a station from the list by using  after you select [NAME SEARCH] in step 1.



To delete the just entered character:

Press .





To enter the same characters or characters on the same dial key sequentially:

(e.g.: To enter "AB")

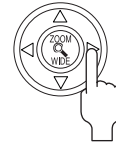
1. Enter "A". (Press the dial  key once.)
2. Press .



3. Enter "B". (Press the dial  key twice.)

- 3 Press  to select the target station or zone (so that it is highlighted) from the list.

* You can select up to 5 stations and/or zones if [ADD/RMV] is displayed on the screen. (See below.)

- 4 Start calling (talking), monitoring or paging by following the procedure for the corresponding performance. (→P. 35-37)

To select two or more stations and/or zones from the list: (When **ADD/RMV** (Add/Remove) is displayed on the screen)

- 1) Press **LIST** as **ADD/RMV** with the target station or zone highlighted.

The station or zone is checked.

* Press **LIST** as **ADD/RMV** again to clear the check.

- 2) Repeat step 1) to select more stations and/or zones.

* You can select up to 5 stations and/or zones. To select 5 stations and/or zones, after checking 4 stations and/or zones, select the 5th one so that it is highlighted. (The 5th station or zone is not checked.)

* You cannot select two or more remote sites.

B Searching for a station in your site by designating an area [STATIONS BY AREA]

1 Select [STATIONS BY AREA] either in the standby mode (→P. 28) or the SEARCH LIST. (→P. 29)

2 Press  to select the target area from the list (so that it is highlighted), and then press **ZOOM/WIDE** to select.

All the stations in the area are displayed in the list.

3 Press  to select the target station (so that it is highlighted).

* You can select up to 5 stations. (→P. 30)

4 Start calling (talking), monitoring or paging by following the procedure for the corresponding performance. (→P. 35-37)

C Searching for a station in your site by designating a station type [STATIONS BY TYPE]

1 Select [STATIONS BY TYPE] from the SEARCH LIST. (→P. 29)

All the station types are displayed in the list.

2 Press  to select the target station type from the list (so that it is highlighted), and then press **ZOOM/WIDE** to select.

All the stations of the selected type are displayed in the list.

3 Press  to select the target station (so that it is highlighted).

* You can select up to 5 stations. (→P. 30)

4 Start calling (talking), monitoring or paging by following the procedure for the corresponding performance. (→P. 35-37)

D Searching for a paging zone in your site from the list [PAGING ZONE]

- 1 Select [PAGING ZONE] from the SEARCH LIST.
(→P. 29)
All the registered paging zones are displayed in the list.
- 2 Press  to select the target zone (so that it is highlighted).
* You can select up to 5 zones. (→P. 30)
- 3 Start paging by following the procedure for paging.
(→P. 37)

E Searching for a chime zone in your site from the list [CHIME ZONE]

- 1 Select [CHIME ZONE] from the SEARCH LIST.
(→P. 29)
All the registered chime zones are displayed in the list.
- 2 Press  to select the target zone (so that it is highlighted).
* You can select up to 5 zones. (→P. 30)
- 3 Start chime paging by following the procedure for chime paging. (→P. 37)

F Searching for a remote site as the target of calling, paging or chime paging from the list [REMOTE SITE]

- 1 Select [REMOTE SITE] from the SEARCH LIST.
(→P. 29)
All the registered remote sites are displayed in the list.
- 2 Press  to select the target site (so that it is highlighted).
* After this step, you can call the target site with the “Normal” priority by pressing [TALK].
For other calling operations such as selecting the priority, refer to P. 35.
- 3 After pressing [ZOOM/WIDE], select the performance you want to do from [CALL], [PAGING] and [CHIME] from the list (so that it is highlighted).
- 4 Start calling, paging or chime paging by following the procedure for the corresponding performance (→P. 35, 37).

NOTES:

- Before you perform calling, paging or chime paging to a remote site, confirm what unit(s) in the site will receive and/or respond to your performance.
- You cannot select two or more remote sites.

Searching for a station or zone by number using the dial keys

- 1 Enter the number of the station or zone in your site you want to search for by using the dial keys in the standby mode.

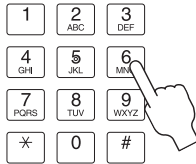

The entered numbers are displayed, and all the stations and/or zones that include the entered number are displayed in the list.

* The search is narrowed down whenever a figure is added.



- 2 Press  to select the target station and/or zone (so that it is highlighted).
* You can select up to 5 stations and/or zones. (→P. 30)
- 3 Start calling (talking), monitoring or paging by following the procedure for the corresponding performance. (→P. 35-37)

Searching for a station, zone or remote site from the placed call or received call list



You can search for a station, zone or remote site from the most recent 20 items of the call and/or (chime) paging record or reception record.

* The items are displayed in the list in chronological order.

G Searching for a station, zone or remote site from the call and/or (chime) paging record list [PLACED CALLS]

- 1 Press  to select [PLACED CALLS] in the standby mode. (→P. 28)
Up to 20 items (target stations, zones or remote sites) of the most recent call and/or (chime) paging you performed are displayed in the list.
- 2 Press  to select the target station, zone or remote site (so that it is highlighted).
- 3 Start calling (talking), monitoring, paging or chime paging by following the procedure for the corresponding performance. (→P. 35-37)

H Searching for a station or remote site from the reception record list [RECEIVED CALLS]

- 1 Press  to select [RECEIVED CALLS] in the standby mode. (→P. 28)
Up to 20 items (stations or remote sites) of the most recent call and/or paging you received are displayed in the list.
- 2 Press  to select the target station or remote site (so that it is highlighted).
- 3 Start calling (talking) or monitoring by following the procedure for the corresponding performance. (→P. 35, 36)

Selecting a station, zone or remote site by using the speed dial buttons

Select a station, zone or remote site registered to one of the speed dials (1 to 6) simply by pressing the corresponding speed dial button.

- 1 Press the speed dial button to which the target station, zone or remote site is registered (highlighted).

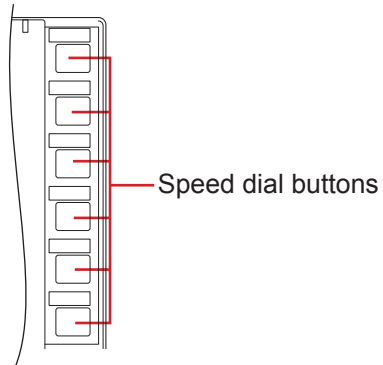

- 2 Start calling (talking), monitoring, paging or chime paging by following the procedure for the corresponding performance. (→P. 35-37)

Calling another station (direct voice call)

Follow the steps below to call a desired door station, room sub station, master station in your site, or a remote site.

- 1 Search for and select the station or remote site you want to call (so that it is highlighted) in one of the search methods. (→P. 28-34)
 - * If you call (the pilot station in) a remote site by searching for it from [REMOTE SITE] of SEARCH LIST, select the target site, and then select [CALL] (so that it is highlighted). (→P. 32)

Refer to the on-screen instructions:

Be sure to make operations by checking the information on the upper part of the monitor. The next operations you can perform are displayed.

e.g.)

[] TALK ... You can start talking by pressing [TALK] or lifting the handset.

* If you will not set the priority, it is set to "Normal".

[] MONI ... You can start monitoring by pressing [MONITOR].

[] PR (or PRIORITY) You can proceed to the priority setting mode by pressing [ZOOM/WIDE].

- 2 To set the priority, press [ZOOM/WIDE], and then press  to select the target priority (so that it is highlighted).
 - * If you will not set the priority, skip this step and press [TALK] or lift the handset. You can start calling (talking).

- 3 Press [TALK] or [ZOOM/WIDE] or lift the handset to start calling (talking).

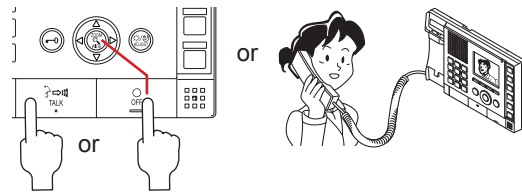

When a tone rings, your voice is heard at the target station and you can also hear sounds at the target station. (Direct voice call)

The receiver can answer the call without pressing any button or lifting the handset. (Talk back)

- * If the target station is a master station, the response of it differs from the PRIVACY MODE setting on the target station. (See the table below.)

PRIVACY MODE setting on the target master station	Response
OFF	Your voice is heard at the target station and you can also hear sounds at the target station.
1	Communication is enabled when the receiver presses [TALK] or lifts the handset. Otherwise you can hear no sound from the target station.
2	When the target station receives your call, a tone notifies you that the target station is in the (PRIVACY MODE) 2. Communication is enabled when the receiver presses [TALK] or lifts the handset. Otherwise you can hear no sound from the target station. * You can adjust the volume of call tone from [RECEIVE VOL] by pressing [SETTING].

- 4 Press [OFF] or hang up the handset to finish communicating.

Monitoring

You can monitor a sub station or multiple sub stations in your site sequentially (scan-monitoring) with a master station.

- * When monitoring a video door station, you can view the image at the station and hear the sound. When monitoring an audio door station or room sub station, you can only hear the sound at the station.

■ Monitoring

- 1 Search for and select the sub station in your site that you want to monitor (so that it is highlighted) in one of the search methods. (→P. 28-34)

NOTE:

You cannot monitor a master station and remote site.

- 2 Press **MONITOR** (when "[CAM] MONI" is displayed).

You can hear the sound and if the station has a camera, you can also view the image.

- 3 Press **OFF** to finish monitoring.

NOTES:

- If the selected station is being used (calling, communicating, being monitored, etc.), you cannot monitor the station.
- If you press **TALK** or lift the handset while monitoring, the communication mode starts with the station after a tone.
- During video monitoring, you can switch Zoom/Wide, make Pan & Tilt control and adjust images on the monitor. (→P. 24-25)

To shift to scan-monitoring

Press **MONITOR** during monitoring.

- * If the station being monitored is a preset one for scan-monitoring, the scan-monitoring starts from the subsequent station in the scan-monitoring order.
- * If the station being monitored is not a preset one for scan-monitoring, the scan-monitoring starts from the first station in the scan-monitoring order.

■ Scan-monitoring

You can monitor the preset stations in your site (up to 20 door stations and/or room sub stations) sequentially, each for the set duration.

- * The stations should be preset in the System setting on a PC.

- 1 Press **MONITOR** in the standby mode.

The stations set for scan-monitoring are monitored sequentially, each for the set duration.

- * If the scan-monitoring lasts 10 minutes, the backlight of the master station monitor will be turned off.

Pressing any key will turn on the backlight again.

- * If the scan-monitoring target station is only one, the scan-monitoring ends after a lapse of approx. 11 minutes.

- 2 Press **OFF** to stop scan-monitoring.

To monitor only the desired station continuously:

Press **MONITOR** when the target station is being monitored during scan-monitoring.

- * Press **MONITOR** again to restart the scan-monitoring.

NOTES:

- Pressing **TALK** is invalid during scan-monitoring.
- If the handset is lifted during scan-monitoring, the scan-monitoring is continued and sounds at the target station can be heard from the handset, and when the handset is hung up or **OFF** is pressed, the scan-monitoring ends.
- If the master station receives a call during scan-monitoring, the scan-monitoring ends automatically.
- If one of the preset stations is being used (calling, communicating, being monitored, etc.) during the scan-monitoring, it will be skipped.
- During the scan-monitoring, the Zoom/Wide, Pan & Tilt, door release and image adjusting functions are disabled. (The camera is fixed in the Wide mode.)

Viewing video images at the target station

When you are receiving a call from, communicating with a video door station, or monitoring a video door station in your site, you can view video images at the target station.

Use the following functions on the master station to control video images as you prefer. (→P. 24-25)

- Switching Zoom/Wide
- Pan & Tilt
- Adjusting images

NOTE:

Video images cannot be controlled during scan-monitoring.

Paging

The system allows you to page (transmit an announcement) the selected zone(s) and/or station(s) simultaneously.

- * For paging a remote site, you can page the zone registered as the target in the site.

NOTE:

If you use zones, register zones in the System setting on a PC in advance.

- 1 Search for and select the zone or remote site you want to page (so that it is highlighted) in one of the search methods. (→P. 28-34)
 - * You can select up to 5 zones and/or stations in your site for paging. (→P. 30)
 - * For paging a zone in a remote site, you cannot select a zone. If you page (the pilot zone in) a remote site by searching for it from [REMOTE SITE] of SEARCH LIST, select the target site, and then select [PAGING] (so that it is highlighted). (→P. 32)

- 2 To set the priority (when "[Q] PRIORITY" is displayed), press **ZOOM/WIDE**, and then press  to select the target priority (so that it is highlighted).
 - * If you will not set the priority, skip this step and press **TALK** or lift the handset. You can start paging after a tone.

- 3 Press **TALK** or **ZOOM/WIDE**, or lift the handset (when "[Q] PAGE" is displayed).

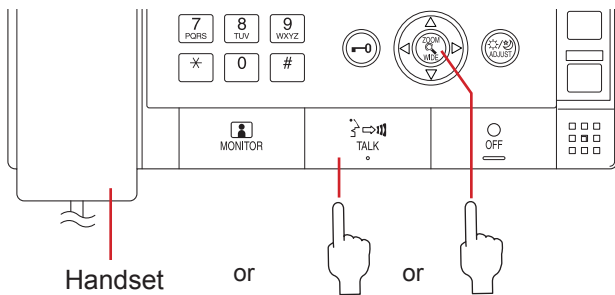

- 4 After a tone rings, start paging.
- 5 A receiver can answer it and communicate with you by pressing **TALK** or lifting the handset, or pressing the external call button*1.
 - * When the priority is set to "BROADCAST", no receiver can answer the paging. The paging will be heard in priority to any other performances (of lower priority) including ongoing communications between stations. (→P. 23)
- 6 When you have finished paging, press **OFF** or hang up the handset.

*1: Connected to a room sub station and the necessary setting should be made in the System setting on a PC. (Be careful not to press the call button on a room sub station by mistake.)

Chime paging

The system allows you to make chime paging (transmit a chime) to all the stations in the designated zone(s) simultaneously.

- * It may take long until the chime is triggered.
- * For chime paging to a remote site, you can make chime paging to the pilot zone registered in the site, and cannot select a sound source.

NOTE:

If you use zones, register zones in the System setting on a PC in advance.

- 1 Search for and select the zone or remote site you want to make chime paging (so that it is highlighted) in one of the search methods. (→P. 32-34)
 - * You can select up to 5 zones in your site for chime paging. (→P. 30)
 - * If you have selected the target zone or remote site by using a speed dial button (so that it is highlighted), or the target remote site from the list of [PLACED CALLS] (so that it is highlighted), skip to step 4.
 - * For chime paging to a zone in a remote site, you cannot select a zone. If you make chime paging to (the pilot zone in) a remote site by searching for it from [REMOTE SITE] of SEARCH LIST, select the target site, and then select [CHIME] (so that it is highlighted) (→P. 32) and then skip to step 4.

- 2 Press **TALK** or **ZOOM/WIDE** (when "[Q] PLAY SOUND" is displayed).

- 3 Press  to select the sound source of chime from the list (so that it is highlighted).

- 4 To set the priority (when "[Q] CHIME [Q] PRIORITY" is displayed), press **ZOOM/WIDE**, and then press  to select the target priority (so that it is highlighted).
 - * If you will not set the priority, skip this step and press **TALK** or lift the handset. Chime paging begins. (Chime paging begins after a ring of tone when the target zone is other than the zone you belongs.)

- 5 Press **TALK** or **ZOOM/WIDE**, or lift the handset (when "[Q] CHIME" is displayed).
Chime paging begins.
(Chime paging begins after a ring of tone when the target zone is other than the zone you belongs.)

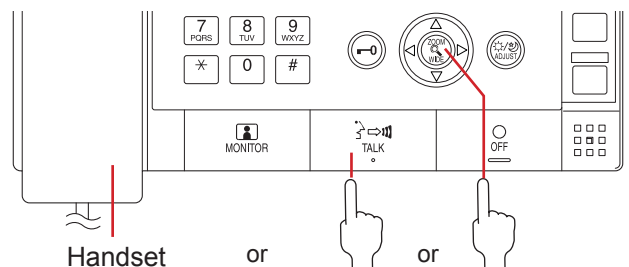

Making chime paging automatically

You can also set chime page automatically on a preset schedule in the System setting on a PC.

OTHER FUNCTIONS

* It may take long until the action is triggered after each operation has been made.

Communicating with telephone (North America only)

■ Receiving a transferred call with telephone

Calling is performed to up to 3 preset telephone numbers sequentially after the preset no-answer time has elapsed for each until it is answered.

■ Transferring call to telephone

A call from a door station (other than IS-IPDV and IS-IPDVF) or room sub station can be automatically transferred to a telephone number in the conditions below.

- When [TELEPHONE TRANSFER] is set to ON in the "INITIAL SETTING" on the master station
- In the period of time set in the System setting on a PC when [SCHEDULE TEL TRANSFER] is set to ON in the "INITIAL SETTING" on the master station

NOTE:

Communication is possible with telephone for calls from a door station (other than IS-IPDV and IS-IPDVF) or room sub station.

■ Answering a transferred call with telephone

Receive a transferred call and answer it (by lifting the handset etc.).

You can talk with the caller after a beep.

* It may take long until you hear a beep. In such a case, you may be able to begin talking by talking to the caller.

■ Releasing door from telephone

When a telephone call is received from a sub station, you can unlock the door connected to the station from the telephone.

NOTE:

Releasing a door is possible for a call from a door station (other than IS-IPDV and IS-IPDVF) or room sub station.

- 1 Receive a transferred call and answer it (by lifting the handset etc.).
- 2 Press "✖" twice during communication.
- 3 Enter the telephone pass code (set in the System settings on a PC).
- 4 Press "✖" once.
Beeps once. (Be sure to check the beep.)

* Beeps three times when a wrong telephone pass code is entered. In that case, try again from step 2.

The door is unlocked for the preset time, and then you can communicate with the station again.

■ Setting off chime from telephone

A chime can be set off to the designated zone from a telephone.

* Only internal chime sources can be used for chime.

- 1 Lift the handset and enter the external number. (For a cell-phone, enter the external number and then make a call operation.)

Audible notice sounds.

* Ask the system administrator or installer for the external number.

- 2 Press "✖" twice, and then enter the telephone pass code after the audible notice.

- 3 Press "✖" again.

Beeps once.

* The communication will be broken when a wrong code is entered. In that case, try again from step 1.

- 4 Press the paging zone number, then "✖".

- 5 Press the chime sound number, then "✖".

- 6 Press the priority number, then "✖".

The chime start tone rings, and the chime paging starts.

NOTES:

- The external number differs from the line to which the IS-IPC is connected. Ask the system administrator or installer for the external number in advance.
- Use the telephone pass code, paging zone number and chime sound number that are set in the System settings on a PC. (Ask the system administrator or installer for the code or number.)
- The priority numbers are as follows.
Normal: (None), 0, 1, 4, 5, 6, 7, 8, 9 or #
Priority: 2
Urgent: 3
- An error sound is heard or the line is disconnected when an error occurs or an incorrect operation is made.
- Depending on the exchange, a message will be sent to the caller to notify him/her that the party is absent. When called to telephone, this system may recognize such a message as an answer and turns the call into communication mode. So use an exchange that does not send such a message or set it so that it does not send a message.
- An outside call just after the previous call ends may not be received.
- If there is a call from a sub station during operation for commencing chime paging to an IS system from telephone, the operation is canceled. In that case, restart the operation from the beginning.

Sending e-mails

You can send e-mails to the designated mail addresses in the following events.

- When calling
- When a calling is unsuccessful
- When an error occurs among units
- When the system starts up

Each of these events that has occurred in the previous 60 seconds is summarized and sent in an e-mail.

* To use this function, you need to register mail addresses in the System settings on a PC in advance.

An example of e-mail contents

```
[Title]: System name
[Body]:
Call: Call <Priority>, <Station number>, <Station name>
Error:
  For stations: Error <Station number>, <Station name>
Start-up: System start <System name>
```

NOTES:

- The mail title and texts cannot be changed.
- When there is a door call at an IP video door station, an e-mail will be sent with a snapshot (QVGA JPEG) at the station attached.
- An e-mail will not be sent for paging and chime paging.
- The body of the message is only in English.

Other functions (combined with connected external devices)

■ Activating room sub stations, IS-SS-2G audio door stations and central control units by detecting contact input

You can set room sub stations, IS-SS-2G audio door stations and central control units to perform the designated operations when detecting an external input. Operations differ from the settings in the System setting on a PC.

Room sub station/IS-SS-2G audio door station

(Example 1: when the action is set to call with an appropriate priority)

When a sensor connected to the room sub station or IS-SS-2G audio door station detects abnormality, or a connected call button is pressed, the room sub station or IS-SS-2G audio door station calls the designated master stations and/or a remote site.

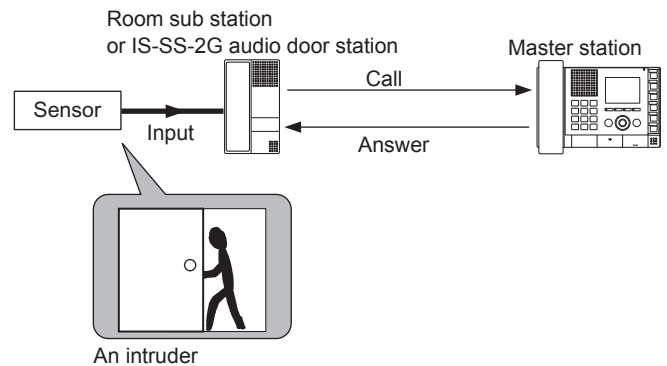

(Example 2: when the action is set to answer the page)

When receiving paging from a master station, by inputting an external signal (for example, by pressing an external button connected to the room sub station), answering the page can be possible.

NOTE:

When using an IS-SS-2G audio door station, only a calling with the "Urgent" priority is possible.

Central control unit

(Example: when the trigger condition is set to broadcast chime)

When a sensor connected to the central control unit detects abnormality or a connected external button is pressed, the central control unit transmits a chime to the set zone.

* It is also possible to set to stop the current chime paging.

■ Activating an external device by detecting the designated action

You can set central control units, add-on control units and room sub control units to activate the connected external devices when detecting the designated action: a call with an appropriate priority, door release, external sound input (central control unit only) or PA output. The trigger condition can be designated by the settings in the System setting on a PC.

TECHNICAL PRECAUTIONS

- **Cleaning:**
Clean all the units with a soft cloth dampened with a neutral household cleanser. Do not use an abrasive cleaner or cloth.
Door stations are water resistant, however clean all the units with a soft cloth dampened with a neutral household cleanser. Do not use an abrasive cleaner or cloth.
- If you are experiencing difficulties in the use of the system, please check our website at <http://www.aiphone.net/>. (Our website does not support IPv6.)

AVAILABLE CHARACTER LIST

The following are the characters that can be entered with each of the dial keys on the master station for station or zone names and numbers.
Some characters are available with a key and they are switched whenever the key is pressed.

Dial key	Characters and number that can be entered with a key									
	Number	Characters								
1	1	.	-	?	!	'	@	_	/	1
2 (ABC)	2	A	B	C	2					
3 (DEF)	3	D	E	F	3					
4 (GHI)	4	G	H	I	4					
5 (JKL)	5	J	K	L	5					
6 (MNO)	6	M	N	O	6					
7 (PQRS)	7	P	Q	R	S					
8 (TUV)	8	T	U	V	8					
9 (WXYZ)	9	W	X	Y	Z	9				
*										
0	0	+	\$	%	&	()	;	0	
#										

SPECIFICATIONS

IP control unit (IS-IPC)

Power source	48V DC (supplied from the power supply unit)
Current consumption	Max. 105mA
Ambient temperature	0 - 40°C (+32°F - +104°F)
Talk channels • Video channels, other channels	Standard (IP) system: 2 talk & 2 constrained video channels, 1 chime, and 1 telephone (North America only)
Central control unit	Max. 1
Room sub control unit	
LAN	Ethernet (10 BASE-T, 100 BASE-TX)
Mounting	Rack-mount (19-inch, 2U rack) or wall-mount
Material	Steel plate
Color	Black
Weight	Approx. 3.6kg (7.94 lbs.)

Central control unit (IS-CCU)

Power source	48V DC (supplied from the power supply unit)
Current consumption	Max. 800mA
Ambient temperature	0 - 40°C (+32°F - +104°F)
Talk channels • Video channels	Local system: 2 talk & 2 video channels, 1 chime
Master station(s)	Max. 4
Video door station(s)	Max. 4
Audio door station(s)	
Room sub station(s)	Max. 2
Add-on control unit	
Room sub control unit	Max. 4
IP control unit	Max. 1
Video output	NTSC BNC (Video channel 1,2)
LAN	Ethernet (10 BASE-T, 100 BASE-TX)
Mounting	Rack-mount (19-inch, 2U rack) or wall-mount
Material	Steel plate
Color	Black
Weight	Approx. 4.0kg (8.82 lbs.)

Add-on control unit (IS-SCU)

Power source	48V DC (supplied from the power supply unit)
Current consumption	Max. 1.2A
Ambient temperature	0 - 40°C (+32°F - +104°F)
Talk channels • Video channels	Local system: 2 talk & 2 video channels, 1 chime
Master station(s)	Max. 8
Video door station(s)	Max. 8
Audio door station(s)	
Room sub station(s)	Max. 8
Video output	
Mounting	NTSC BNC (Video channel 1,2)
Material	Rack-mount (19-inch, 2U rack) or wall-mount
Color	Steel plate
Weight	Black
	Approx. 4.0kg (8.82 lbs.)

Room sub control unit (IS-RCU)

Power source	48V DC (supplied from the power supply unit)
Current consumption	Max. 1.8A
Ambient temperature	0 - 40°C (+32°F - +104°F)
Talk channels	Local system: 2 talk channels, 1 chime
Audio door station(s)	Max. 30
Room sub station(s)	
Mounting	Rack-mount (19-inch, 2U rack) or wall-mount
Material	Steel plate
Color	Black
Weight	Approx. 4.0kg (8.82 lbs.)

Color monitor master station (IS-MV)

Power source	Supplied from the central control unit or add-on control unit
Communication	Handset: Simultaneous communication (When press-to-talk (PTT) is not set) Hands-free: Auto-voice actuation or Press-to-talk (PTT)
Ambient temperature	0 - 40°C (+32°F - +104°F)
Monitor	3.5 inch color LCD monitor
Call history	Call record: 20 Reception record: 20
Paging capacity	Simultaneous paging to max. 5 zones and/or stations, or 1 pilot zone of a remote site
Mounting	Desktop use (with or without desktop stand) or wall-mount
Electrical box	1 or 3-gang box*
Material	Flame resisting ABS resin
Color	Black
Weight	Approx. 820g (1.81 lbs.)

*: 1-gang box.....For wiring only (Fix the unit to the wall directly)

3-gang box.....For wiring and fixing the unit

Color monitor IP master station (IS-IPMV)

Power source	48V DC (PoE) 24V DC (supplied from the power supply unit)
Current consumption	Max. 65mA (PoE) Max. 130mA (when power supply unit is used)
Communication	Handset: Simultaneous communication (When press-to-talk (PTT) is not set) Hands-free: Auto-voice actuation or Press-to-talk (PTT)
Ambient temperature	0 - 40°C (+32°F - +104°F)
Monitor	3.5 inch color LCD monitor
Call history	Call record: 20 Reception record: 20
Paging capacity	Simultaneous paging to max. 5 zones and/or stations, or 1 pilot zone of a remote site
Mounting	Desktop use (with or without desktop stand) or wall-mount
Electrical box	1 or 3-gang box*
Material	Flame resisting ABS resin
Color	Black
Weight	Approx. 820g (1.81 lbs.)

*: 1-gang box.....For wiring only (Fix the unit to the wall directly)

3-gang box.....For wiring and fixing the unit

Vandal-resistant video door station (surface-mount) (IS-DV)

Power source	Supplied from the central control unit or add-on control unit
Communication	Open voice hands-free communication
Ambient temperature	-10 - 60°C (+14°F - +140°F)
Camera	1/4-inch color CMOS
Minimum illumination	5 Lux
Camera angle	Wide: Approx. 170° (horizontal)
Mounting	Surface-wall mount (directly to wall)
Material	Front panel: Aluminum die-cast Main unit: Flame resisting PC+ABS resin
Color	Front panel: Dull-gray silver
Weight	Approx. 520g (1.15 lbs.)
Remarks	Weather-resistant

IP vandal-resistant video door station (surface-mount) (IS-IPDV)

Power source	48V DC (PoE) 24V DC (supplied from the power supply unit)
Consumption	Max. 85mA (PoE) Max. 160mA (when power supply unit is used)
Communication	Open voice hands-free communication
Ambient temperature	-10 - 60°C (+14°F - +140°F)
Camera	1/4-inch color CMOS
Minimum illumination	5 Lux
Camera angle	Wide: Approx. 170° (horizontal)
Mounting	Surface-wall mount (directly to wall)
Material	Front panel: Aluminum die-cast Main unit: Flame resisting PC+ABS resin
Color	Front panel: Dull-gray silver
Weight	Approx. 540g (1.19 lbs.)
Remarks	Weather-resistant

Vandal-resistant video door station (flush-mount) (IS-DVF)

Power source	Supplied from the central control unit or add-on control unit
Communication	Open voice hands-free communication
Ambient temperature	-10 - 60° C (+14°F - +140°F)
Camera	1/4-inch color CMOS
Minimum illumination	5 Lux
Camera angle	Wide: Approx. 170° (horizontal)
Mounting	Flush-mount
Electrical box	Not used (mounts on built-in back box.)
Material	Front panel: Stainless steel Main unit: Flame resisting PC+ABS resin
Color	Front panel: Stainless steel, vertical hair-line processed Back box: Black
Weight	Approx. 810g (1.79 lbs.) Back box: Approx. 600g (1.32 lbs.)
Remarks	Weather-resistant

IP vandal-resistant video door station (flush-mount) (IS-IPDVF)

Power source	48V DC (PoE) 24V DC (supplied from the power supply unit)
Consumption	Max. 85mA (PoE) Max. 160mA (when power supply unit is used)
Communication	Open voice hands-free communication
Ambient temperature	-10 - 60° C (+14°F - +140°F)
Camera	1/4-inch color CMOS
Minimum illumination	5 Lux
Camera angle	Wide: Approx. 170° (horizontal)
Mounting	Flush-mount
Electrical box	Not used (mounts on built-in back box.)
Material	Front panel: Stainless steel Main unit: Flame resisting PC+ABS resin
Color	Front panel: Stainless steel, vertical hair-line processed Back box: Black
Weight	Approx. 860g (1.90 lbs.) Back box: Approx. 600g (1.32 lbs.)
Remarks	Weather-resistant

Vandal-resistant audio door station (flash-mount) (IS-SS)

Power source	Supplied from the central control unit, add-on control unit or room sub control unit
Communication	Open voice hands-free communication
Ambient temperature	-10 - 60°C (+14°F - +140°F)
Mounting	Flush-mount
Electrical box	Not used (mounts on built-in back box.)
Material	Front panel: Stainless steel Main unit: Flame resisting PC+ABC resin
Color	Front panel: Stainless steel, vertical hair-line processed Back box: Black
Weight	Approx. 820g (1.81 lbs.) Back box: Approx. 600g (1.32 lbs.)
Remarks	Weather-resistant

Vandal-resistant audio door station (flash-mount) (IS-SS-2G)

Power source	Supplied from the central control unit, add-on control unit or room sub control unit
Communication	Open voice hands-free communication
Ambient temperature	-10 - 60°C (+14°F - +140°F)
Mounting	Flush-mount
Electrical box	2-gang box
Material	Front panel: Stainless steel Main unit: Flame resisting PC+ABC resin
Color	Front panel: Stainless steel, vertical hair-line processed
Weight	Approx. 370g (0.82 lbs.)
Remarks	Weather-resistant (Protection class: IP54)

Room sub station (IS-RS)

Power source	Supplied from the central control unit, add-on control unit or room sub control unit
Communication	Handset: Simultaneous communication Hands-free: Auto-voice actuation
Ambient temperature	0 - 40°C (+32°F - +104°F)
Mounting	Surface-wall mount (directly to wall or electrical box)
Electrical box	1-gang box
Material	Flame resisting ABS resin
Color	Black
Weight	Approx. 530g (1.17 lbs.)

Power supply unit (IS-PU-UL, IS-PU-S)

Power source	AC 100 - 240V, 50/60Hz.
Power consumption	120W
Ambient temperature	0 - 40°C (+32°F - +104°F)
(Secondary) Output voltage	DC 48V
(Secondary) Output current	2.1A
Mounting	Wall-mount (with IS-RACK) or rack-mount (with IS-RACK)
Material	Steel plate
Color	Black
Weight	Approx. 1.5kg (3.31 lbs.)

WARRANTY

Aiphone warrants its products to be free from defects of material and workmanship under normal use and service for a period of two years after delivery to the ultimate user and will repair free of charge or replace at no charge, should it become defective upon which examination shall disclose to be defective and under warranty. Aiphone reserves unto itself the sole right to make the final decision whether there is a defect in materials and/or workmanship; and whether or not the product is within the warranty. This warranty shall not apply to any Aiphone product which has been subject to misuse, neglect, accident, power surge, or to use in violation of instructions furnished, nor extended to units which have been repaired or altered outside of the factory. This warranty does not cover batteries or damage caused by batteries used in connection with the unit. This warranty covers bench repairs only, and any repairs must be made at the shop or place designated in writing by Aiphone. This warranty is limited to the standard specifications listed in the operation manual. This warranty does not cover any supplementary function of a third party product that is added by users or suppliers. Please note that any damage or other issues caused by failure of function or interconnection with Aiphone products is also not covered by this warranty. Aiphone will not be responsible for any costs incurred involving on site service calls. Aiphone will not provide compensation for any loss or damage incurred by the breakdown or malfunction of its products during use, or for any consequent inconvenience or losses that may result.

The object area of  is the EU.

FCC

This device complies with Part 15 of the FCC Rules. Operation is subject to the following two conditions: (1) this device may not cause harmful interference, and (2) this device must accept any interference received, including interference that may cause undesired operation.

This equipment has been tested and found to comply with the limits for a Class B digital device, pursuant to Part 15 of the FCC Rules. These limits are designed to provide reasonable protection against harmful interference in a residential installation. This equipment generates, uses, and can radiate radio frequency energy, and if not installed and used in accordance with the instructions, may cause harmful interference to radio communications. However, there is no guarantee that interference will not occur in a particular installation. If this equipment does cause harmful interference to radio or television reception, which can be determined by turning the equipment off and on, the user is encouraged to try to correct the interference by one or more of the following measures:

- Reorient or relocate the receiving antenna
- Connect the equipment to an outlet on a circuit different from that to which the receiver is connected. Increase the separation between the equipment and receiver.
- Consult the dealer or an experienced radio/TV technician for help.

<For US market>

This equipment complies with Part 68 of the FCC rules and the requirements adopted by the ACTA. On the back side of this equipment is a label that contains, among other information, a product identifier in the format US:AIHMM02BIS-IPC. If requested, this number must be provided to the telephone company.

USOC Jack, RJ11C is available to this equipment.

A plug and jack used to connect this equipment to the premises wiring and telephone network must comply with the applicable FCC Part 68 rules and requirements adopted by the ACTA. A complaint telephone cord and modular plug is provided with this product. It is designed to be connected to a compatible modular jack that is also complaint. See installation manuals for details.

The REN is used to determine the number of devices that may be connected to the telephone line. Excessive RENs on the telephone line may result in the devices not ringing in response to an incoming call. In most, but not all areas, the sum of RENs should not exceed five (5.0). To be certain of the number of devices that may be connected to a line, as determined by the total RENs, contact the local telephone company. For products approved after July 23, 2001, the REN for this product is part of the product identifier that has the format US:AIHMM02BIS-IPC. The digits represented by 02 are the REN without a decimal point (e.g., 03 is a REN of 0.3).

If IP Control Unit (IS-IPC) causes harm to the telephone network, the telephone company will notify you in advance that temporary discontinuance of service may be required. But if advance notice isn't practical, the telephone company will notify the customer as soon as possible. Also, you will be advised of your right to file a complaint with the FCC if you believe it is necessary.

The telephone company may make changes in its facilities, equipment, operations or procedures that could affect the operation of the equipment. If this happens the telephone company will provide advance notice in order for you to make necessary modifications to maintain uninterrupted service.

If trouble is experienced with IP Control Unit (IS-IPC), for repair or warranty information, please contact Aiphone Corporation 425-455-0510 (U.S.A). If the equipment is causing harm to the telephone network, the telephone company may request that you disconnect the equipment until the problem is resolved.

Connection to party line service is subject to state tariffs. Contact the state public utility commission, public service commission or corporation commission for information.

<For Canada market>

This product meets the applicable Industry Canada technical specifications.

The Ringer Equivalence Number (REN) is an indication of the maximum number of devices allowed to be connected to a telephone interface. The termination of an interface may consist of any combination of devices subject only to the requirement that the sum of the RENs of all the devices not exceed five.

 **AIPHONE**®
Providing Peace of Mind
<http://www.aiphone.net/>

AIPHONE CO., LTD., NAGOYA, JAPAN