

AIPHONE

NI-SOFT

OPERATION MANUAL

GETTING STARTED

USING THE NI-SOFT

APPENDIX

Thank you for selecting Aiphone for your communication needs. Please read this manual carefully before using this product.
* Please make sure to read this manual for safe and correct use of the product, and keep it in a safe place for future reference.

Please note that images and illustrations depicted in this manual may differ from the actual product.

Contents

Introduction	3
Notices	3
Unpacking	3
Connections	3

GETTING STARTED

4

Installing the NI-SOFT	4
System requirements for PC.....	4
Installing	5
Starting up the NI-SOFT	7
Exiting the NI-SOFT	8
Configuring the initial setup of the NI-SOFT	9

USING THE NI-SOFT

10

Displaying the call history by specifying search criteria	10
Displaying the call history	10
Displaying the call history list in graph form	13
Configuring the sub station settings	14

APPENDIX.....

15

Troubleshooting.....	15
----------------------	----

Introduction

This product is application software that can be used by installing it on a PC connected with the master station. With this software, you can check the history of calls/answers in a table or graph format.

Notices

- Depending on the computer, it may not be useable.
 - We will under no conditions be liable for any damages or losses resulting from this product's contents or specifications.
 - This manual was created by Aiphone Co., Ltd., all rights reserved. Copying a part of or this entire manual without prior permission from Aiphone Co., Ltd. is strictly forbidden.
 - Please note that this manual may be revised or changed without prior notice.
- Please note that product specifications may be changed for the sake of improvement without prior notice.
 - Please be aware that it is the customer's responsibility to ensure that their computer is secure. We will under no conditions be liable for security failures.

Unpacking

After unpacking, check that the following are included.

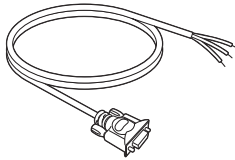
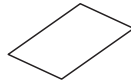
CD-ROM	RS232C cable	Information sheet
		
Contents: NI-SOFT (this software), NI-SOFT OPERATION MANUAL (this manual)		Contents: Product Key, China RoHS

* Please keep these items in a safe place for future use.

Connections

Connect a PC on which you will install the NI-SOFT to the master station with the included RS232C cable.

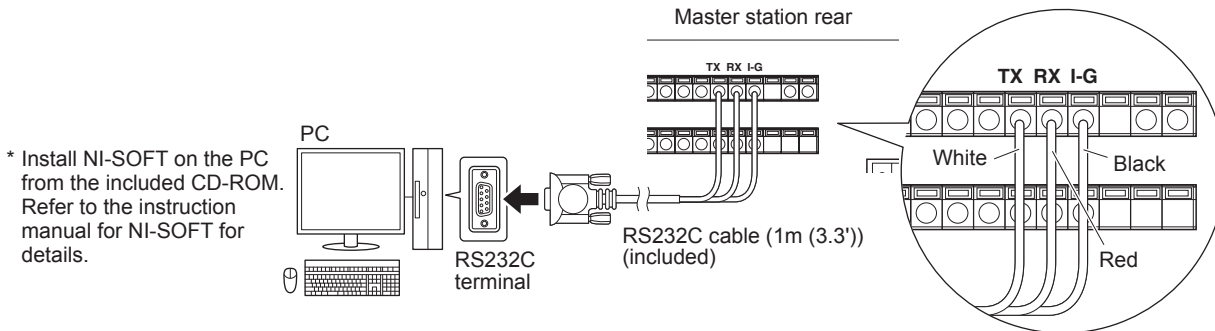

* When extending the RS232C cable, the distance between the master station and the PC should be 15m (50') or less.

GETTING STARTED

Installing the NI-SOFT

Install the NI-SOFT on your PC from the CD-ROM.

NOTES:

- The PC should be operable 24 hours a day. Call history is obtained only while the NI-SOFT is running.
- Call history is not obtained in the following cases:
 - When the NI-SOFT is not running
 - When the PC is in the standby or sleep mode, or the system is logged off
 - When the PC cannot communicate with the master station for any cause

System requirements for PC

Your PC must meet the following system requirements to use the NI-SOFT.

Also refer to the instruction manual supplied with your PC.

OS (English ver. only)	Windows 7 Home Premium/Professional/Ultimate (Service Pack 1, 32/64bit) Windows 8.1/Pro (32/64bit)
Processor	2.7 GHz or higher
System memory (RAM)	2 GB RAM or higher
Hard disk	Total 100 MB or higher (*1)
Run-time	Microsoft® .NET Framework 4.5 (*2)
Display	1024 (W) x 768 (H) or higher, 16-bit or more
Serial port	RS-232C, D-sub 9-pin
Fonts	Arial

(*1): If the software is to be installed onto a drive other than C: drive, both the C: drive and the installation drive each require 50 MB or more of memory.

(*2): If the specified Run-time is not installed on the PC, it will be installed automatically when installing the NI-SOFT.



- The NI-SOFT may not run, or may not operate correctly (such as freezes occurring) on a PC with specifications below the necessary requirements.
- We recommend using a PC and CD-ROM/DVD-ROM drive that exceed the basic system requirements.
- The NI-SOFT is registered to the start-up for the user designated when it was installed. (The NI-SOFT starts up automatically when logged in to the Windows.)
- When the system memory of the PC is running out, the NI-SOFT reboots the Windows to prevent the PC from being frozen. If there is concern of the occurrence of Windows reboot, configure the Windows so that login is performed automatically with the user's account with sufficient attention given to security.
- It is recommended to install a PC exclusive for the NI-SOFT and acquire a dedicated account to obtain a complete call history.

Microsoft and Windows are either registered trademarks or trademarks of Microsoft Corporation in the United States and/or other countries.

Installing

- 1 Insert the CD-ROM into your PC.

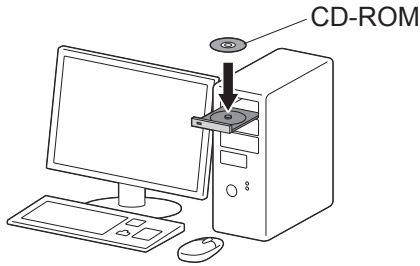

- 2 Run "Setup.exe" in the CD-ROM by double-clicking it.
- 3 Start the installation by following the on-screen instructions.

Read "Software License Agreement" carefully, and then select **I Agree**.

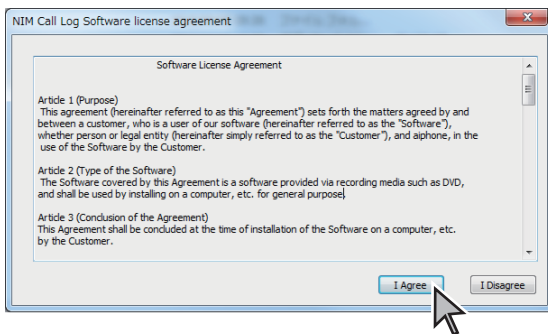

- 4 Input the Product Key, and click **OK**.

* The Product Key can be found on the information sheet, "Product Key for NI-SOFT".

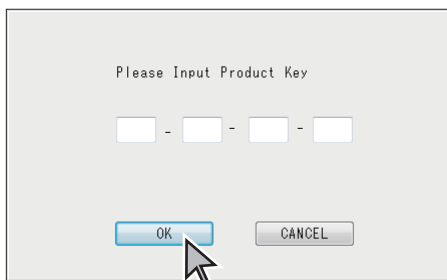

NOTE:

If ".NET Framework 4.5" is not already installed, the .NET Framework installation window is displayed. Follow the on-screen instructions to install. (It might be nothing displayed for a while to install.)

- 5 Read the description in the [Welcome to the NIM Call Log Software Setup Wizard] window, and then click **Next**.

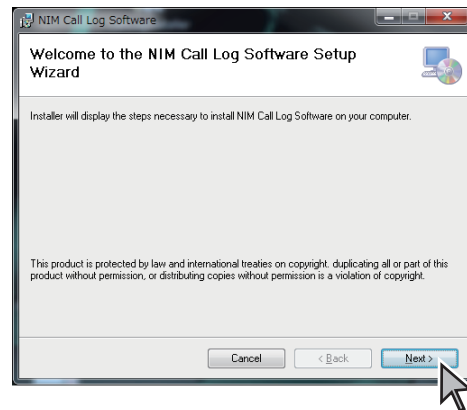

- 6 Select the folder and the PC in which the NI-SOFT is to be installed.

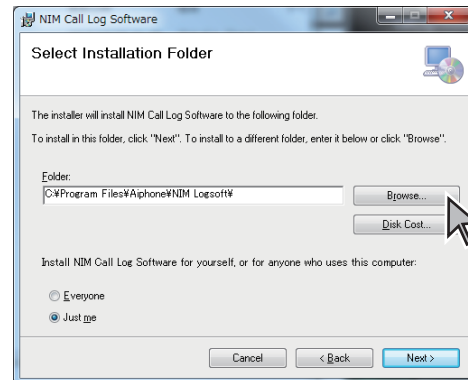

- 7 Click **Next** to continue the installation.

Dialogs are displayed to confirm whether or not you want to place a shortcut for the NI-SOFT in the Start Menu and on the desktop. Click **YES** or **NO**.

- 8 When the [Installation Complete] window appears, click **Close** to finish the installation.

* After the installation has finished, restart the PC.

NOTES:

- When starting up the NI-SOFT, if a security or virus check warning is displayed, please allow the NI-SOFT to continue.
- When the [User Account Control Settings] window appears, click **OK** to continue the installation.
- Depending on the OS of a PC, different screens may be displayed. Follow the on-screen instructions to install.

■ Uninstalling

When you need to uninstall the NI-SOFT, follow the procedure below.

* The uninstallation procedure differs depending on the Windows OS version. Confirm the procedure for the Windows OS on your PC.

1 Click the Windows' "Start" button, and then click "Control panel".

The control panel opens.

2 Click "Programs and Features".

3 Select "NIM Call Log Software", and then click "Uninstall".

A dialog is displayed to confirm whether or not you want to keep log data and program settings. Click YES or NO.

When uninstalling has been finished successfully, the message "The program was successfully uninstalled" appears.

Starting up the NI-SOFT

Read the instruction below while viewing the actual display of the PC.

1 Start up the PC.

The following login window is displayed automatically after starting or restarting the PC.



- * When you first start up the NI-SOFT after it has been installed, a dialog box is displayed saying that COM port setting has not been made. Click [OK] and proceed to the next step. After the initial setup (→ P.9 **1**), the dialog box will not be displayed again.

2 Click "Login".

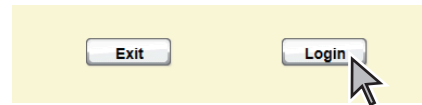

- * When the password entry box is displayed, enter the password, and then click "Login". When you start up the NI-SOFT for the first time, entering password is not needed. You can set up a password for security purposes if needed. (→ P. 9)
- * If you do not want to log into the NI-SOFT, click [Exit].



The [Call log] window is displayed.

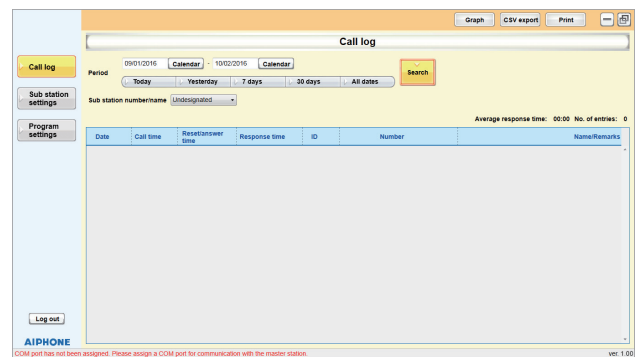

Buttons available in all the windows

Click to close the window.

The window closes and "AIPHONE" icon remains on the task bar. Clicking the icon opens the window again.

[Call log] window

Click to open the [Call log] window. (→P. 10)

Click to open the [Sub station settings] window. (→P. 14)

Click to open the [Program settings] window. (→P. 9)

Click to log out of the NI-SOFT. (→P. 8)

Click to maximize the window. Click this again to restore the window to normal size.

Status bar
Displays the current status of the NI-SOFT.

Version of the NI-SOFT

Date	Call time	Reset/answer time	Response time	ID	Number	Name/Remarks
10/02/2016	17:49:46	17:49:50	00:04	4	104	
10/02/2016	17:10:41	17:10:43	00:02	5	105	
10/02/2016	17:06:31	17:06:33	00:02	1	101	
10/02/2016	17:04:54	17:04:57	00:03	3	103	
10/02/2016	17:04:38	17:04:42	00:04	3	103	
10/02/2016	17:04:23	17:04:28	00:05	4	104	
10/02/2016	17:04:10	17:04:15	00:05	4	104	
10/02/2016	17:03:54	17:03:58	00:04	1	101	
10/02/2016	17:03:34	17:03:37	00:03	1	101	
10/02/2016	17:03:10	17:03:15	00:05	2	102	
10/02/2016	17:02:46	17:02:55	00:09	2	102	
10/02/2016	17:01:46	17:01:49	00:03	1	101	
10/02/2016	17:01:21	17:01:26	00:05	1	101	
10/02/2016	17:00:28	17:00:33	00:05	5	105	

Exiting the NI-SOFT

NOTE:

When **Exit** is clicked, the NI-SOFT stops running. While the NI-SOFT is not running, call history logs cannot be obtained, so the call history in that period is not displayed.

- 1 Click **Log out**.

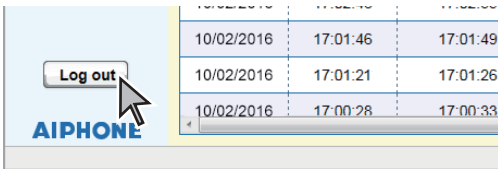

A confirmation message is displayed.

- 2 Click **OK** to continue the exit operation.

- 3 Click **Exit**.

A confirmation message is displayed.

- 4 Click **OK** to exit the NI-SOFT.

When you start the NI-SOFT again;

Double-click the "  " icon on the desktop.

NIM Call Log Software

* If another location is specified for installing the NI-SOFT during installation, run "NIMlog.exe" from the location where it is installed.

Configuring the initial setup of the NI-SOFT

Configure the initial setup before using the NI-SOFT.

First click **Program settings** to display the **[Program settings]** window.

Then set up the items of **1**, **2**, **3** below.

(**1** : Required, **2**, **3** : As needed)

[Program settings] window

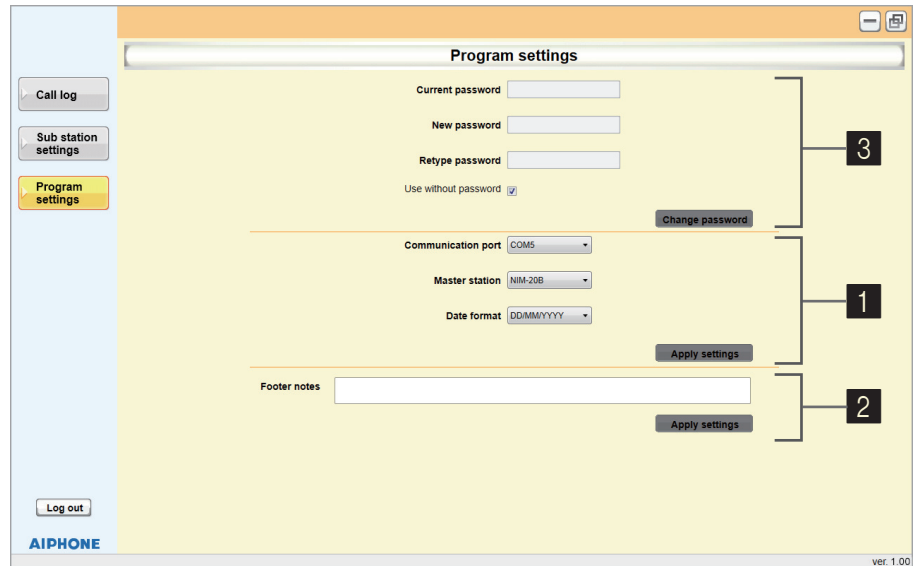

1 Configuring the initial setup (Required)

1 Set up the following items.

[Communication port]:

Select the communication port to be used from the drop-down list.

[Master station]:

Select the master station model connected with this PC from the drop-down list.

[Date format]:

Select the year-month-day format to be used in the window from the drop-down list.

DD: day MM: month YYYY: year

2 Click **Apply settings** to save the setting changes of these items.

NOTES:

- The items that cannot be changed or selected are grayed out.
- If you change the window or click **Log out** without saving the setting changes, a notice dialog box appears saying that “Exit without saving? (Changes to settings will not be saved)”. To save the changes, Click **Cancel**, and then click **Apply settings**.

2 Registering a note in the footer area

When printing out a call history list etc., the registered note is printed in the footer area of a print sheet.

* Only English one-byte alphanumeric characters can be used for a note. Up to 80 characters can be inputted.

1 Enter a note in the text box of **[Footer notes]**.

2 Click **Apply settings** to save the note.

3 Setting up a login password

You can set up a password for security purposes if needed.

* Only English one-byte alphanumeric characters can be used for a password. Up to 32 characters can be inputted.

Setting up a password for the first time

- 1 Uncheck the check box of **[Use without password]**.
* Unless this check box is unchecked, a password cannot be entered.
- 2 Enter a new password in the **[New password]** box.
- 3 Enter the same new password in the **[Retype password]** box again.
- 4 Click **Change password** to save the password.

* Inputting the set password is required when logging into the NI-SOFT the next time.

Changing the password

- 1 Enter the current password in the **[Current password]** box.
- 2 Enter the new password in the **[New password]** box.
- 3 Enter the new password in the **[Retype password]** box again.
- 4 Click **Change password** to save the new password.

NOTES:

- If you will not use a password for login, check the check box of **[Use without password]** and then click **Change password**.
- The items that cannot be changed or selected are grayed out.
- If you have forgotten the password, you need to re-install the NI-SOFT.

Displaying the call history by specifying search criteria

The call history is displayed in the [Call log] window.

NOTES:

- Call history logs are not obtained in the following period of time, so the call history in such a period of time cannot be displayed.
 - When the NI-SOFT is not running

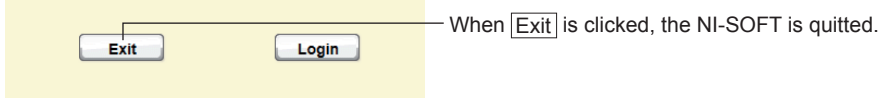

- When the PC is in the standby or sleep mode, or the system is logged off
- When the PC cannot communicate with the master station for any cause
- Call history does not updated on a real-time basis. Call history logs can be obtained only while the NI-SOFT is running.

Displaying the call history

Click [Call log] to display the [Call log] window.

Specify search criteria by following the procedure below to limit the scope of target calls.

1 Select the target period of time from the following.

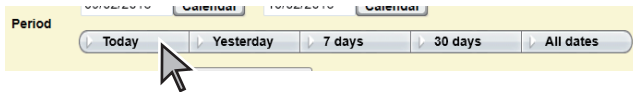

[Today]

[Yesterday]

[7 days]: 7 days including the current day

[30 days]: 30 days including the current day

[All dates]: No limitation of term

You can also specify the term by selecting start and end dates from the calendar respectively.

NOTE:

The specified dates are not updated automatically. Specify the target dates and conduct a search again to update the call history data.

2 If needed, specify the sub station ID, number or name/remarks by selecting the search item from the drop-down list.



[Undesignated]: none specified

[ID]:

When this is selected, a drop-down list is displayed. Select the target ID from the list.

* All the IDs recorded in the call history are displayed in the list.

[Number]:

1 After selecting this, click **Select** on the right hand of the window.

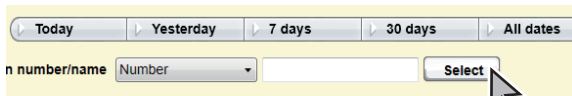

The **[Number]** dialog box is displayed.

- 2 Select the target sub station name, bed number, etc. within the dialog box.
- 3 Click **Select**.

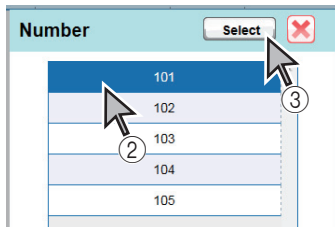

The selected name or number is displayed in the input box.

* The names or numbers displayed in the dialog box are those recorded in the call history list. When a new name or number is registered in the **[Sub station setting]** window (→P. 14), it will be displayed in this dialog box after it has been recorded and displayed in the call history list.

[Name/Remarks]:

1 After selecting this, click **Select** on the right hand of the window.

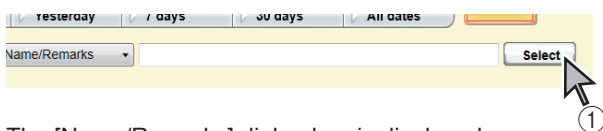

The **[Name/Remarks]** dialog box is displayed.

- 2 Select the target name, remark, etc. within the dialog box.
- 3 Click **Select**.

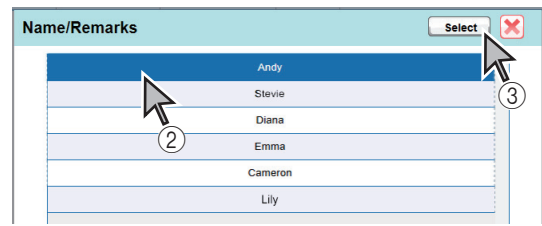

The selected name, remark, etc. is displayed in the input box.

* The names, remarks, etc. displayed in the dialog box are those recorded in the call history list. When a new name or remark is registered in the **[Sub station setting]** window (→P. 14), it will be displayed in this dialog box after it has been recorded and displayed in the call history list.

3 Click **Search**.

The history of calls that meet the specified criteria is displayed in the list.

Date	Call time	Reset/answer time	Response time	ID	Number
10/02/2016	17:49:46	17:49:50	00:04	4	104
10/02/2016	17:10:41	17:10:43	00:02	5	105

< Table column headings >

Date: The date when the call was received by the master station.

Call time: The time when the call was received by the master station.

Reset/answer time: The time when the call was answered or reset.

Response time: The length of time from when the call was received to answered or reset.

ID: The ID of the target sub station.

Number: The target sub station name, bed number, etc.

Name/Remarks: The target sub station name, remarks, etc.

* The history is displayed in ascending or descending order. The order changes each time an item name on the table head is clicked.
ex.)

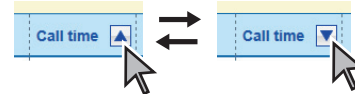

* When call records are not all displayed, scroll the window up or down by using the vertical scroll bar.

NOTES:

- A maximum of 100,000 call records can be stored. When the number of call records exceed 100,000, the old ones are overwritten.
- When the response time of a call is more than 59 minutes and 59 seconds, it is displayed as 59 minutes and 59 seconds.
- The NI-SOFT does not support displaying summer time.

■ Printing out the displayed call history list

- 1 Click **Print** on the [Call log] window.



The print preview window is displayed.

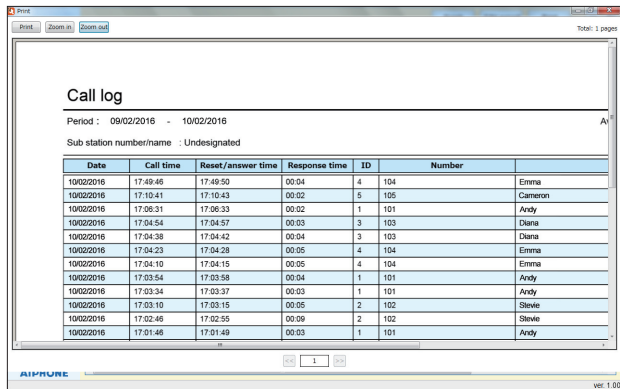

Zoom in: Click to enlarge the preview.

Zoom out: Click to reduce the preview.

- * When the preview is not fully displayed, scroll the window by using the scroll bar.
- * When the call history list is to be printed in two or more sheets, you can display other pages by clicking **<<** (previous page) or **>>** (next page). You can also designate the page number you wish to preview by entering the number.

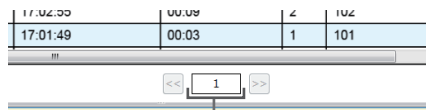

Current page number

- * You can enter the desired page number in this box.

- 2 Click **Print** to print out the current preview window.



NOTES:

- A maximum of 3,000 call records (100 pages) can be printed out at one time.
- Do not quit the NI-SOFT until the printing is completed. The printing may not finish completely.

■ Exporting the displayed call history list in CSV format

- 1 Click **CSV export**.

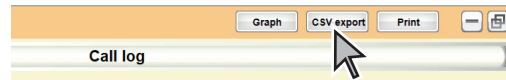

The "Save as" window is displayed.

- 2 If needed, change the file name and the destination to save.
- 3 Click **Save** to save the file.

Displaying the call history list in graph form

- 1 Click **Graph** on the [Call log] window.

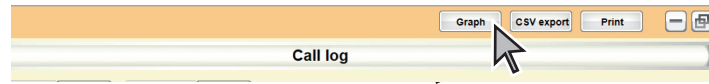

The [Graph] window is displayed, and the current call history list is displayed in bar graph sorted by response time.

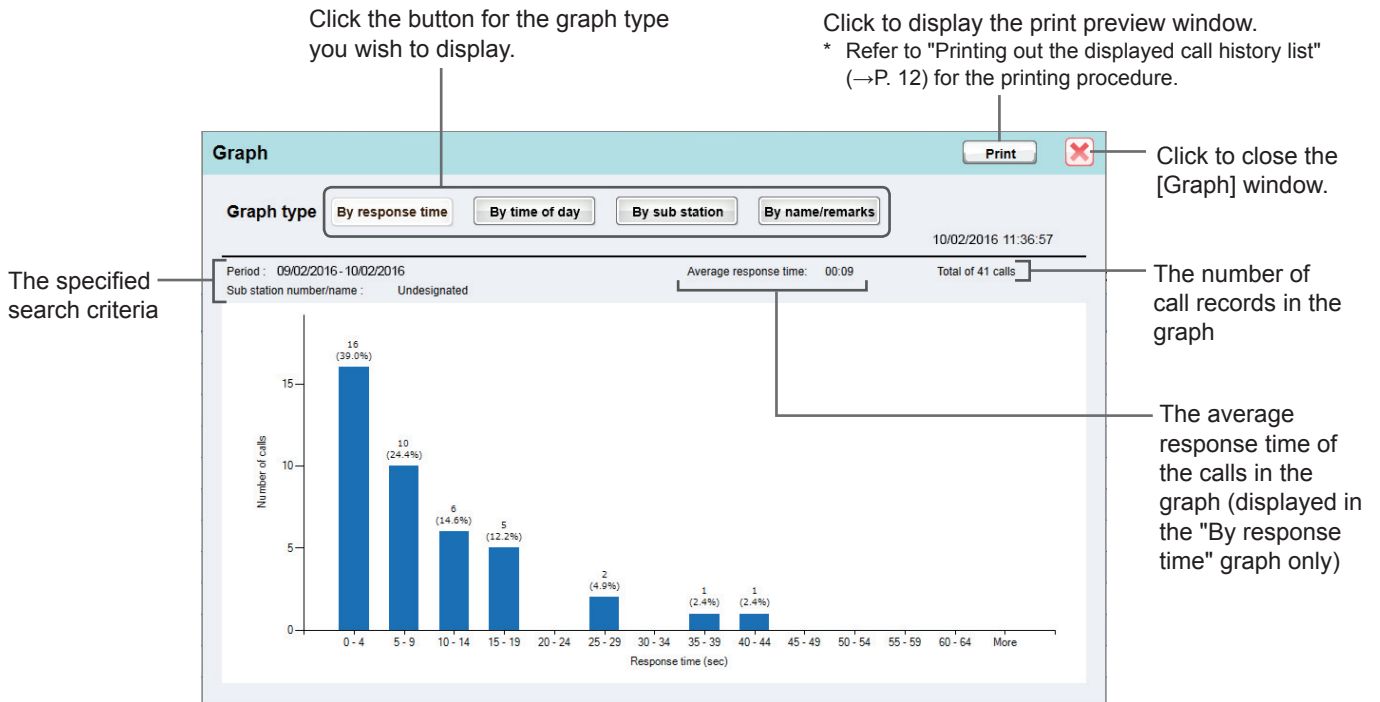

* The screen image shows a bar graph sorted "By response time".

- 2 If needed, change the graph type by clicking the corresponding button.

By response time (default): Click to display a call history list in bar graph sorted by response time.

By time of day: Click to display a call history list in bar graph sorted by time of day.

By sub station: Click to display a call history list in bar graph sorted by sub station ID. Up to 20 sub station IDs are displayed in descending order when more than 20 sub stations are connected to the master station.

By name/remarks: Click to display a call history list in bar graph sorted by name/remarks.

Configuring the sub station settings

Configure the settings for the sub stations connected to the master station.

Set number (station name, bed number, etc.) and name/remarks etc. for each of the sub stations.

The number, names, remarks, etc. registered in this window are used as the search criteria for calls in the [Call log] window.

- 1 Click **Sub station setting** to display the [Sub station settings] window.

Click to save the setting changes.

Click to display the print preview window.
* Refer to "Printing out the displayed call history list" (→P. 12) for the printing procedure.

Click to export the sub station setting data in this window in CSV format.
* Refer to "Exporting the displayed call history list in CSV format" (→P. 12) for the exporting procedure.

All the IDs for the sub stations connected (or to be connected) to the master station are displayed. (See below for details about the sub station IDs.)

ID	Number	Name/Remarks
1	101	Andy
2	102	Steve
3	103	Diana
4	104	Emma
5	105	Cameron
6		
7		
8		
9		
10		
11		
12		
13		
14		
15		
16		
17		
18		
19		

- 2 Enter a station name, bed number, etc. in the "Number" column, and enter remarks or other information in the "Name/Remarks" column for each ID.

Item	Max number of characters in a cell
Number	16
Name/Remarks	40

* Double quotation mark (") and backslash mark (\) are disabled.

- 3 Click **Apply** to save the settings.

NOTES:

- Usable font is "Arial" only.
- If you try to change the window without clicking **Apply**, the pop-up, "Exit without saving?" is displayed. Click either **OK** or **Cancel**.

ID configuration

IDs are configured on the master station as shown in the illustration on the right.

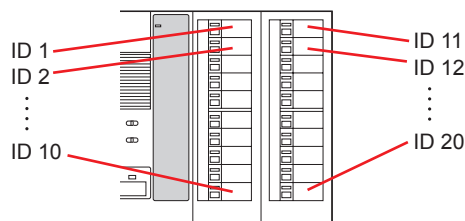

* The illustration shows the master station, 20-call (NIM-20B).

Troubleshooting

If the software fails to operate normally, check the following points to determine whether the fault can be corrected by the simple measures suggested. If it cannot be corrected, or if the fault is not listed in the "Symptom" column, contact the system supplier or service center for help.

Symptom	Cause	Remedy
NI-SOFT software is not found or no display on the computer monitor installed with the NI-SOFT software.	The software is not installed successfully.	Install the software again.
	The short-cut of NI-SOFT software disappeared.	Search the installed NI-SOFT software files.
Product Key code is not found.	-	Confirm the attached information sheet that contains the Product Key code of NI-SOFT.
NI-SOFT software does not show history.	Improper RS-232C connection	Verify wiring type and distance.
Error message, "Communication with master station cannot be established. Please check the cable" is displayed.	Improper RS-232C connection	Verify the connection of RS-232C cable. The error message will be remained on the screen until corrected.



Issue Date: Feb. 2016

FK2246 (A) P0216 SZ 57290

AIPHONE CO., LTD., NAGOYA, JAPAN